

Explosion-proof Camera User Manual

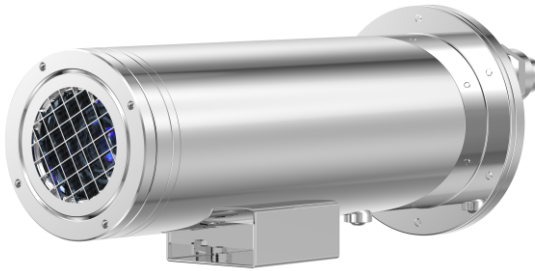

Issue

V 1.0

Date

2023-11-25





Precautions

Precautions

Fully understand this document before using this device, and strictly observe rules in this document when using this device. If you install this device in public places, provide the tip "You have entered the area of electronic surveillance" in an eye-catching place. Failure to correctly use electrical products may cause fire and severe injuries. To prevent accidents, carefully read the following context:

Symbols

This document may contain the following symbols whose meanings are described accordingly.

Symbol	Description
 DANGER	It alerts you to fatal dangers which, if not avoided, may cause deaths or severe injuries.
 WARNING	It alerts you to moderate dangers which, if not avoided, may cause minor or moderate injuries.
 CAUTION	It alerts you to risks. Neglect of these risks may cause device damage, data loss, device performance deterioration, or unpredictable results.
 TIP	It provides a tip that may help you resolve problems or save time.
 NOTE	It provides additional information.



DANGER

To prevent electric shocks or other dangers, keep power plugs dry and clean.



WARNING

- Strictly observe installation requirements when installing the device. The manufacturer shall not be held responsible for device damage caused by users' non-conformance to these requirements.
- Strictly conform to local electrical safety standards and use power adapters which are marked with the LPS standard when installing and using this device. Otherwise, this device may be damaged.

- Use accessories delivered with this device. The voltage must meet input voltage requirements for this device.
- If this device is installed in places with unsteady voltage, ground the device to discharge high energy such as electrical surges in order to prevent the power supply from burning out.
- When this device is in use, ensure that no water or any liquid flows into the device. If water or liquid unexpectedly flows into the device, immediately power off the device and disconnect all cables (such as power cables and network cables) from this device.
- Do not place the thermal imaging camera and unpackaged products at a radiation source with a high intensity regardless of whether the device is in the normal power-on state, for example, the sun, laser, and electric arc welder, and place the thermal imaging camera and unpackaged products against objects with a high heat source, for example, the sun. Otherwise, the accuracy of the thermal imaging camera will be affected. In addition, the detector in the thermal imaging camera may be permanently damaged.
- If this device is installed in places where thunder and lightning frequently occur, ground the device nearby to discharge high energy such as thunder strikes in order to prevent device damage.



CAUTION

- Unless otherwise specified in the user manual, do not use the thermal imaging camera in an environment with the temperature lower than -20°C (-4°F) or higher than 60°C ($+140^{\circ}\text{F}$). Otherwise, the images displayed by the thermal imaging camera are abnormal and the device may be damaged if working beyond the temperature range for a long period.
- During the outdoor installation, prevent the morning or evening sunlight incidence to the lens of the thermal imaging camera. The sun shade must be installed and adjusted according to the angle of the sunlight illumination.
- Avoid heavy loads, intensive shakes, and soaking to prevent damages during transportation and storage. The warranty does not cover any device damage that is caused during secondary packaging and transportation after the original packaging is taken apart.
- This device is a static sensitivity device. Improper static may damage the thermal imaging camera. ESD protection measures and reliable grounding must be well prepared for device installation and uninstallation.
- Protect this device from fall-down and intensive strikes, keep the device away from magnetic field interference, and do not install the device in places with shaking surfaces or under shocks.
- Use a soft and dry cloth to clean the device body. In case that the dirt is hard to remove, use a dry cloth dipped in a small amount of mild detergent and gently wipe the device, and then dry it again. Pay special attention to the front window of the thermal imaging camera because this is precision optics. If the front window has water spots, use a clean and soft cloth moistened with water to wipe it. If the front

window needs further cleaning, use a soft cloth dampened with isopropyl alcohol or detergent. Improper cleaning can cause damage to the device.

- The lens window of the thermal imaging camera is designed to be applicable to an outdoor environment. The window is coated with durable coating material, but may require frequent cleaning. When you found lens image degradation or excessive accumulation of pollutants, you should clear up the window in a timely manner. Exercise caution when you use this device in severe sandstorm (such as deserts) or corrosive environments (such as offshore). Improper use may cause surface coating off.
- Do not jam the ventilation opening. Follow the installation instructions provided in this document when installing the device.
- Keep the device away from heat sources such as radiators, electric heaters, or other heat equipment.
- Keep the device away from moist, dusty, extremely hot or cold places, or places with strong electric radiation.
- If the device is installed outdoors, take insect- and moisture-proof measures to avoid circuit board corrosion that can affect monitoring.
- Remove the power plug if the device is idle for a long time.
- Before unpacking, check whether the fragile sticker is damaged. If the fragile sticker is damaged, contact customer services or sales personnel. The manufacturer shall not be held responsible for any artificial damage of the fragile sticker.

Special Announcement

All complete products sold by the manufacturer are delivered along with nameplates, operation instructions, and accessories after strict inspection. The manufacturer shall not be held responsible for counterfeit products.

This manual may contain misprints, technology information that is not accurate enough, or product function and operation description that is slightly inconsistent with the actual product. The manufacturer will update this manual according to product function enhancement or changes and regularly update the software and hardware described in this manual. Update information will be added to new versions of this manual without prior notice.

This manual is only for reference and does not ensure that the information is totally consistent with the actual product. For consistency, see the actual product.

Contents

Precautions	I
Contents	IV
1 Product Overview	1
1.1 Thermal imaging principles and advantages.....	1
2 Device Dimension	2
2.1 Dimensions of explosion-proof network cameras.	2
3 Installation	2
3.1 Product installation method.....	2
3.2 Basic requirements for installation.....	4
3.3 Installation space and installation strength.....	4
3.4 Cable connection.....	4
4 Quick Configuration	7
4.1 Login and Logout.....	7
4.2 Main Page Layout.....	8
4.3 Changing the Password.....	10
4.4 Browse Video.....	11
4.5 Install Plugins.....	12
4.6 People Counting.....	13
4.7 Setting Local Network Parameters.....	13
5 Configuring Thermal	17
5.1 Temperature Parameters.....	17
5.2 Ambient Temperature.....	23
5.3 Temperature Area.....	23
5.4 Privacy Zone Masking.....	29
5.5 Schedule Linkage.....	30
5.6 Defect Pixel Correction.....	38
6 Thermal Channel Image Settings	41
6.1 Access the Image Settings Interface.....	41
6.2 Image Settings Parameter description.....	42

6.3 Image.....	43
6.4 Scene	44
6.5 Set Pseudocolor.....	45
6.6 FFC Control	46
6.7 Noise Reduction.....	47
7 Intelligent Analysis	49
7.1 Intrusion	49
7.2 Single Line Crossing	53
7.3 Double Line Crossing.....	56
7.4 Multi-Loitering.....	60
7.5 Retrograde	63
7.6 People Counting.....	65
7.7 Enter Area.....	68
7.8 Leave Area	71
7.9 Smart Motion	74
8 Advanced Intelligent Analysis.....	79
8.1 Smoker Detection	79
8.2 Fire Spot Detection.....	82
9 AI Multi-object.....	86
B Common Emission Rate.....	91

1 Product Overview

1.1 Thermal imaging principles and advantages

As long as the temperature of any object is higher than absolute temperature zero (-273.15 degrees), although it does not emit light, it can radiate infrared rays. Infrared rays are also called thermal radiation. The infrared rays radiated by objects of different temperatures are absorbed by infrared heat detectors, causing temperature changes, thereby producing electrical effects. The electrical signals are then amplified and processed to obtain a thermal image corresponding to the heat distribution on the surface of the object, which is called "infrared". Thermal Imaging".

- Adapt to any lighting environment

Traditional cameras rely on natural or ambient lighting for photography, while infrared thermal imaging cameras do not require any lighting and rely on the infrared heat energy radiated by the object itself to produce clear images. The infrared thermal imaging camera is suitable for any lighting environment and is not affected by strong light. It can clearly detect and find targets no matter day or night, and identify camouflaged and hidden targets. Therefore, 24-hour monitoring day/night can truly be achieved.

- Target thermal energy distribution temperature field monitoring

Infrared thermal imaging cameras can display the temperature field of an object, turning the target surface temperature distribution that cannot be directly seen by the human eye into a thermal image representing the target surface temperature distribution that the human eye can see. By monitoring the temperature field, it can be discovered immediately. Temperature anomalies prevent hidden dangers caused by temperature anomalies, such as fires.

- Has real cloud and fog penetration capabilities

The atmosphere, clouds, smoke, etc. absorb visible light and near-infrared rays, but are transparent to thermal infrared rays of 3 to 5 microns (mid-wave infrared region) and 8 to 14 microns (long-wave infrared region). Therefore, it is difficult for traditional cameras to operate in dense clouds and fog. Clear images can be captured in various environments, while thermal imaging cameras can effectively penetrate the atmosphere, clouds, fog and other environments to capture clear images.

2 Device Dimension

2.1 Dimensions of explosion-proof network cameras.

Figure 2-1 shows the dimensions of device.

Figure 2-1 Dimensions (unit: mm)

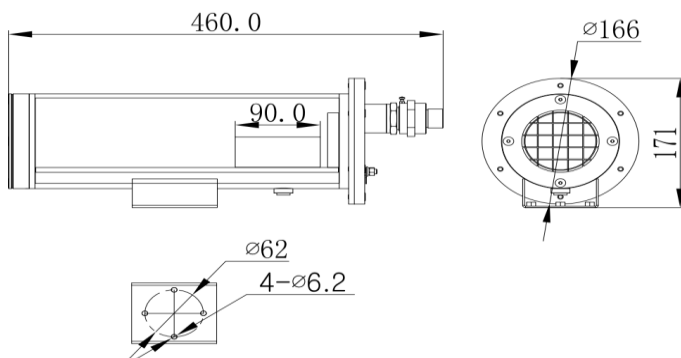

3 Installation

3.1 Product installation method

Install the bracket in an appropriate position and select the mounting hole. The first step is to install the universal joint on the camera base; Then adjust the universal joint fasteners according to the area that needs to be monitored to ensure that the camera direction is correct; Finally, use the explosion-proof camera to fix the bracket with an anchor or bolt. The junction box is always installed in a location that is easy to install and maintain. Figure 3-1 shows the bracket specifications and universal joints.

Figure 3-1 Installation and dimensions of the bracket

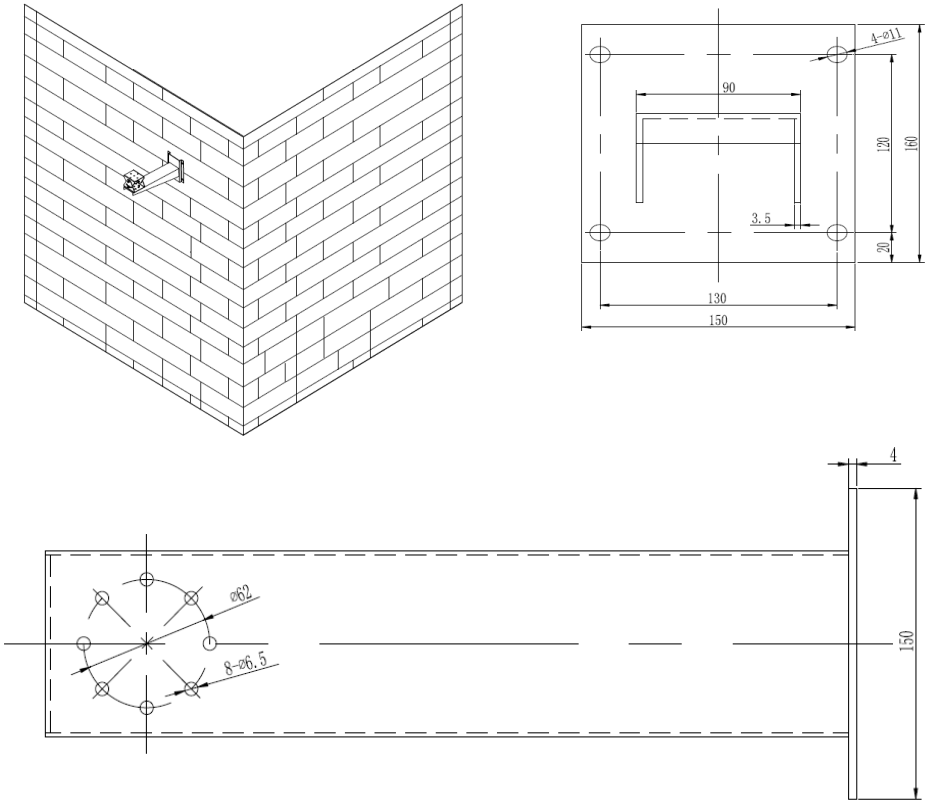

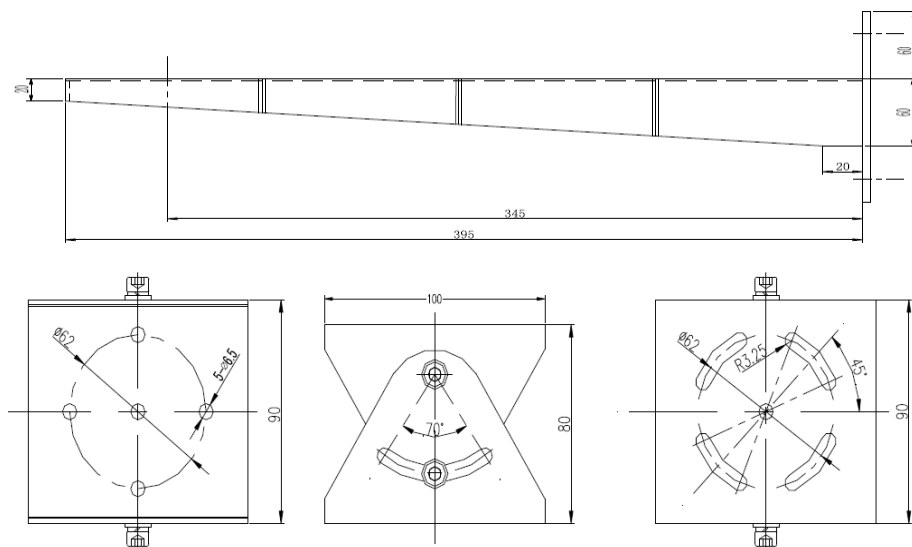

3.2 Basic requirements for installation

The installation location and environment meet the requirements mentioned in the technical parameters. The installer should have fully read and understood the contents of this manual and have the corresponding system installation qualification and maintenance work qualification certificates.

Open the packaging box to confirm the accessory information. If there are any missing accessories, please contact the supplier.

3.3 Installation space and installation strength

Please confirm that the installation site can accommodate this product as well as the space for loading equipment and installation structural components, and ensure that the load-bearing capacity of the installed walls and brackets can reach a safe limit of 4 times the weight of the entire equipment.

3.4 Cable connection



The different models may have different cables, please refer to actual product.

Figure 3-2 Multi-connector Combination Cables

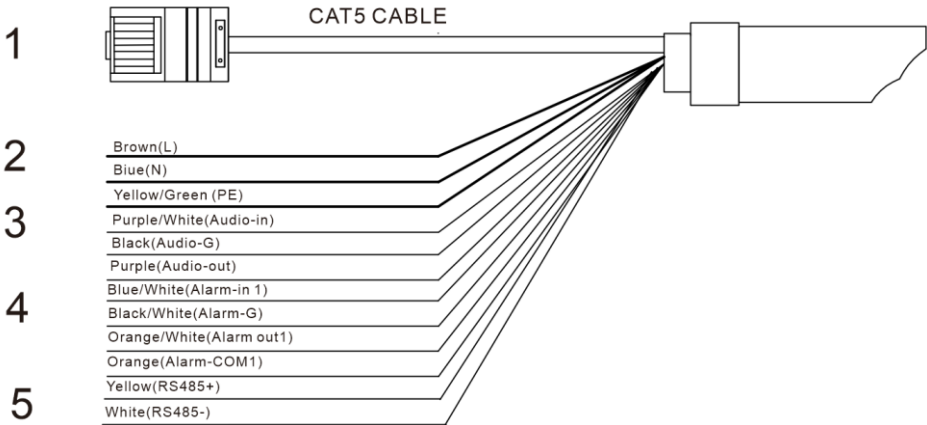

Table 3-1 Multi-connector Combination Cables

ID	Core of Cable	Functions
1	Network interface	Connect to the standard Ethernet cable.
2	AC100~240V	Power interface, connects to the AC100~240V power supply. Brown: L Blue: N Yellow/green: PE
3	Audio	Audio input: Connect external audio devices such as speakers Audio output: Input audio signals and receive analog audio signals from devices such as pickups. Purple/White: Audio input Black: Audio-G Purple: Audio output
4	Alarm	Audio input: Connect external audio devices such as speakers Audio output: Input audio signals and receive analog audio signals from

		devices such as pickups. Purple/White: Audio input Black: Audio-G Purple: Audio output
5	RS485	Yellow: RS485+ white : RS485-

4 Quick Configuration

4.1 Login and Logout



CAUTION

You must use Edge/Chrome/Firefox to access the web management system; otherwise, some functions may be unavailable.

Login system

Open the Microsoft Edge, enter the IP address of IP camera (default value: 192.168.0.121) in the address box, and press Enter.

The login page is displayed, as shown in Figure 4-1.

Figure 4-1 Login Page

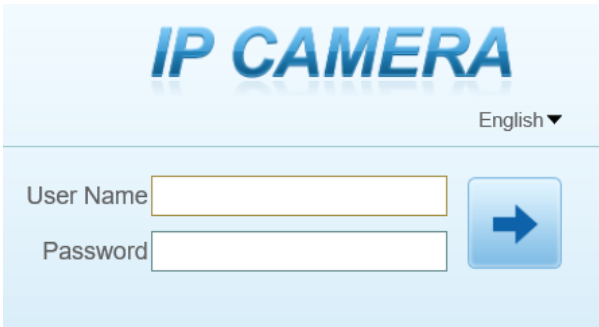

Input the User Name and Password.

 **NOTE**

- The default user name is **admin**. The default password is **admin**. Change the password when you login the system for first time to ensure system security.
- You can change the system display language on the login page..

Click Login

The main page is displayed.

----**End**

Sign out

To logout of system, click  in the upper right corner of the main page, the login page is display after you log out of the system.

----**End**

4.2 Main Page Layout

On the main page, you can view Live video, set parameter, Video parameter, Video control, PTZ control, PTZ Configure and log out of the system. Figure 4-3 is shown the main page layout. Table 4-1 lists the elements on the main page layout.

Figure 4-2 Main page layout

Figure 4-3 Homepage Layout

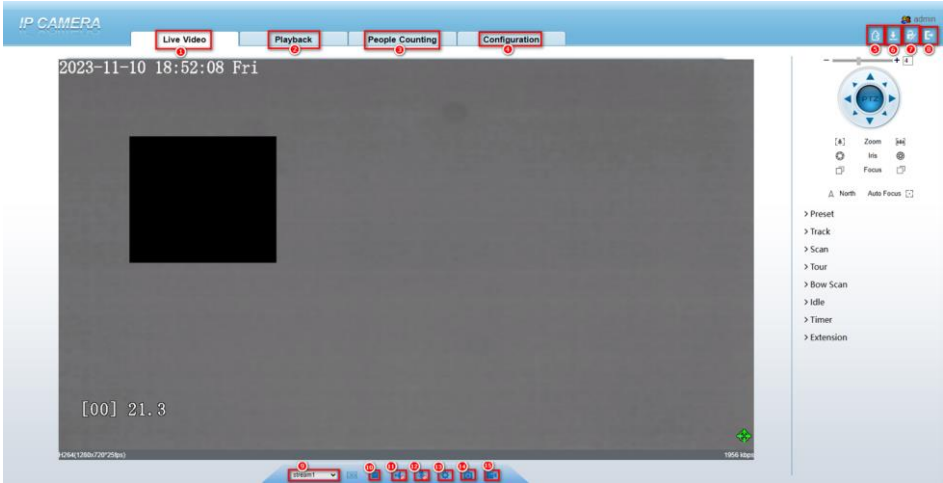







Table 4-1 Elements on the Homepage

No.	Element	Description
1	Live video	Live videos are played in this area. You can also set sensor parameters.
2	Playback	You can query the playback videos in this area. NOTE Only when the SD card have videos that user can query the playback videos.
3	People Counting	You can query graph data about the number of people if the statistical function has been configured and statistical data is available.
4	Device configuration	You can choose a menu to set device parameters, including the device information, audio and video streams, alarm setting, and privacy mask function.
5	Plugins of IP camera Local Server	You can click  to download the plugins. If you use the device web page too frequencies. Suggest you Install the plugins first.
6	Backup Status	The icon  display the record video backup status. It display backup list and completion degree while you click the icon in non plug-in. And just display backup status in plug-in model.

No.	Element	Description
7	Change password	You can click  to change the password.
8	Sign Out	You can click  to return to the login page.
9	Stream	There are three streams. Choose one type from drop-down list.
10	Pause/Start	Close live video or play live video.
11	Audio	Open or close audio.
12	Interphone	Open or close interphone.
13	Setting	Click the icon, it will jump to configuration page.
14	Snapshot	Click the icon, it will snapshot.
15	Local record	Click the icon, it will record video and save.

When the device generates an alarm, the alarm icon  is displayed. You can click  to view the alarm information.

**NOTE**

When the device accepts an alarm signal, the alarm icon will display within 10s in the web management system.

----End

4.3 Changing the Password

Description

User can click  to change the password for logging into the system.

Procedure

Click  in the upper right corner of the main page.

The **Change Password** dialog box is displayed, as shown in Figure 4-4.

Figure 4-4 Change Password Dialog Box

Change Password [x]

Old Password

New Password

Confirm

Password Advice:

1. Advice the password length of eight characters.
2. Advice the password includes numbers, capital letters, lowercase letters and special characters.
3. Advice the password can not be the same as username.

OK Cancel

 **NOTE**

- The change password page will be displayed if you don't change the default password when you login the system for the first time.

Input the old password, new password, and confirm password.
Click **OK**.

If the message "**Change password success**" is displayed, the password is successfully changed. If the password fails to be changed, the cause is displayed. (For example, the new password length couldn't be less than eight.)

----End

4.4 Browse Video

Users can view live video in web pages. Browsers like Edge/Chrome are recommended.

Preparation

There are two methods to play Live video, no-plugins and plugins. If you login web page use Edge application, the Live video will be played by no-plugins method. This method requires high hardware performance for computer graphics cards.

So we suggest to ensure the Live video can be play properly, you had better perform install plugins in your computer, please following operation below :

Open the Edge, login the web page. Click plugins  icon to download IP camera local Server plugins. The web page will pop up tip box after the download task finished. as shown in Figure 4-5

Figure 4-5 Tip download box



Step 1. Click icon , it will pop up an operation options, click the title keep, then click keep away after the confirm box pop up, as show in Figure 4-6.

Figure 4-6 download plugins



Step 2. Then the IPCLocalServer.exe plugins download successful.

4.5 Install Plugins

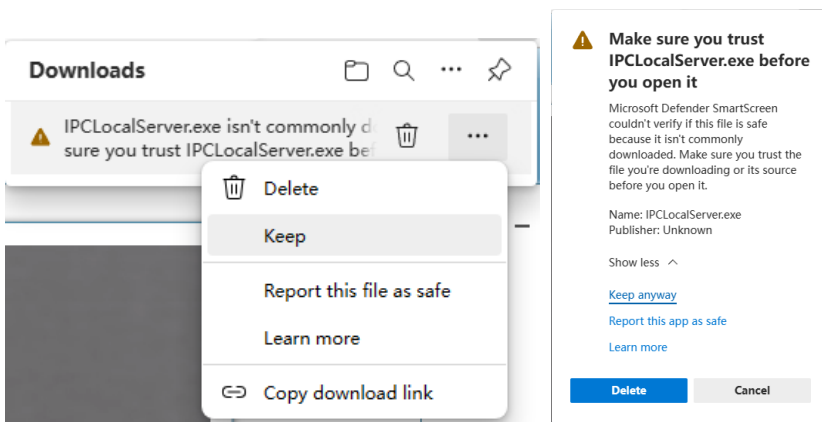
You download the plugins before, then we need to install the plugins. Click open file or double click the IPCLocalServer.exe as shown in Figure 4-7 to start install process.

Figure 4-7 Download the plugin page



Step 2. It will pop up install box to help user to install plugins, you just need to click twice 'next' button , once 'install' button, once 'finish' button to finish the installation.

Step 3. Reopen or refresh the browser after installation, the plugins is going working.

----End

4.6 People Counting

Figure 4-8 People Counting Interface

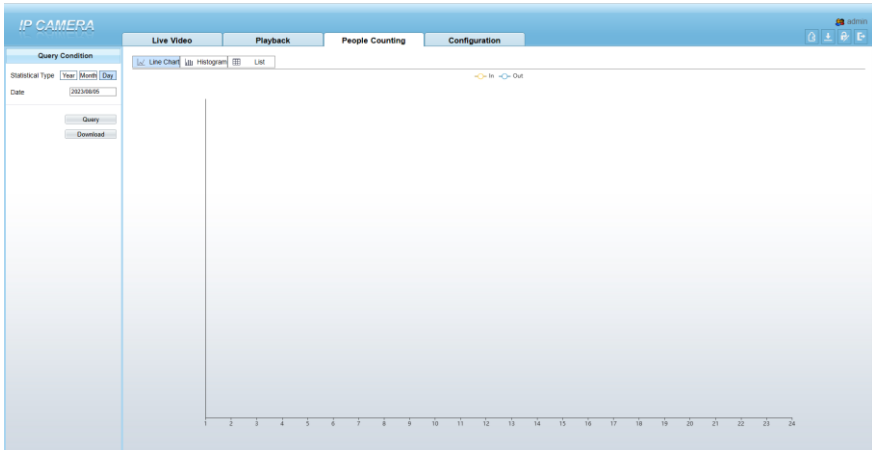

User can choose the querying mode (year, month, day).

The data can be viewed directly, or downloaded them.

The statistic can be showed by line chart, histogram, list.

4.7 Setting Local Network Parameters

Description

Local network parameters include:

- IP protocol

- IP address
- Subnet mask
- Default gateway
- Dynamic Host Configuration Protocol (DHCP)
- Preferred Domain Name System (DNS) server
- Alternate DNS server
- MTU

Procedure

Choose Configuration > Device > Local Network.

The **Local Network** page is displayed, as shown in Figure 4-9.

Figure 4-9 Local Network

Local Network

Network Card ID	1
IP Protocol	IPv4

DHCP OFF

IP Address	192.168.0.121
Subnet Mask	255.255.255.0
Default Gateway	192.168.0.1

Preferred DNS Server	192.168.0.1
Alternate DNS Server	192.168.0.2
MTU(1280-1500)	1500

Set the parameters according to Table 4-2.

Table 4-2 Local Network Parameters

Parameter	Description	Setting
IP Protocol	IPv4 is the IP protocol that uses an address length of 32 bits.	[Setting method] Select a value from the drop-down list box. [Default value] IPv4
DHCP	The device automatically obtains the IP address from the DHCP server.	[Setting method] Click the option button. NOTE To query the current IP address of the device, you must query it on the platform based on the device name.
DHCP IP	IP address that the DHCP server assigned to the device.	N/A
IP Address	Device IP address that can be set as required.	[Setting method] Enter a value manually. [Default value] 192.168.0.121
Subnet Mask	Subnet mask of the network adapter.	[Setting method] Enter a value manually. [Default value] 255.255.255.0
Default Gateway	This parameter must be set if the client accesses the device through a gateway.	[Setting method] Enter a value manually. [Default value] 192.168.0.1
Preferred DNS Server	IP address of a DNS server.	[Setting method] Enter a value manually. [Default value] 192.168.0.1
Alternate DNS Server	IP address of a domain server. If the preferred DNS server is faulty, the device uses the alternate DNS server to resolve domain names.	[Setting method] Enter a value manually. [Default value] 192.168.0.2

Parameter	Description	Setting
MTU	Set the maximum value of network transmission data packets.	[Setting method] Enter a value manually. NOTE The MTU value is range from 1280 to 1500, the default value is 1500, Please do not change it arbitrarily.

Click **OK**.

- If the message "**Apply success**" is displayed, click OK. The system saves the settings. The message "**Set network param's success**, Please login system again" is displayed. Use the new IP address to log in to the web management system.
- If the message "Invalid IP Address", "**Invalid Subnet Mask**", "**Invalid default gateway**", "**Invalid primary DNS**", or "**Invalid space DNS**" is displayed, set the parameters correctly.

**NOTE**

- If you set only the Subnet Mask, Default Gateway, Preferred DNS Server, and Alternate DNS Server parameters, you do not need to login to the system again.
- You can click Reset to restore the previous parameters if required.

----**End**

5 Configuring Thermal

5.1 Temperature Parameters

Temperature parameters include temperature unit, ambient type, ambient temperature, cavity temperature, correctional coefficient, area temperature display mode, area temperature type, measure mode, area alarm interval and so on.

Operation Procedure

Choose **Configuration > Thermal > Temperature Parameters**.

The **Temperature Parameters** page is displayed, as shown in Figure 5-1.

Figure 5-1 Temperature Parameters Interface

 **Temperature Parameters**

Temperature Measurements		<input type="checkbox"/> ON
Temperature Units	<input type="text" value="Celsius"/>	<input type="button" value="v"/>
Length Units	<input type="text" value="Meters"/>	<input type="button" value="v"/>
Cavity Temperature	<input type="text" value="35.73"/>	
Correction Coefficient	<input type="text" value="0.00"/>	
Area ID Display Mode	<input type="text" value="Area ID"/>	<input type="button" value="v"/>
Area Temperature Display Mode	<input type="text" value="Low Left"/>	<input type="button" value="v"/>
Font Border		<input type="checkbox"/> ON
Font Size	<input type="text" value="Mid"/>	<input type="button" value="v"/>
Area Temperature Type	<input type="text" value="Highest Temperature"/>	<input type="button" value="v"/>
Measure Mode	<input type="text" value="General"/>	<input type="button" value="v"/>
Display Alarm Area		<input type="checkbox"/> OFF
Area Alarm Interval (1-1800s)	<input type="text" value="10"/>	
Area Alarm Delay (0-10s)	<input type="text" value="0"/>	
Temperature Range	<input type="text" value="-20.0 ~ 150.0"/>	<input type="button" value="v"/>
Prevent Overheating	<input type="text" value="Auto"/>	<input type="button" value="v"/>
Duration (5-60s)	<input type="text" value="60"/>	

Set the parameters according to Table 5-1.

Table 5-1 Temperature Parameters

Parameter	Description	Setting
Temperature Unit	Celsius and Fahrenheit temperature units are available.	[Setting method] Select a value from the drop-down list box. [Default value] Celsius
Length units	Meters and feet length units are available.	[Setting method] Select a value from the drop-down list box. [Default value] Meters
Cavity Temperature	The cavity temperature of camera.	N/A
Correction Coefficient	Correction coefficient is refer to the deviation of measured object temperature and actual temperature, is offset value. For example: 1. The measured object temperature is 20, and actual temperature is 20.5, so the correction coefficient should be 0.5 . 2. The measured object temperature is 20, and actual temperature is 19.5, so the correction coefficient should be -0.5. NOTE User should contact the technical support staff of our company at this condition to make sure to apply	[Setting method] Enter a value manually. [Default value] 0.00
Area ID display mode	There two mode to display, area ID and area name	[Setting method] Select a value from the drop-down list box. [Default value] Area ID

Parameter	Description	Setting
Area Temperature Display Mode	The display position of temperature information on the live-video image.	[Setting method] Select a value from the drop-down list box. [Default value] Low left
Font Border	Enable to bold the font	[Setting method] Enable or disable [Default value] Disable
Font size	There are three font size can be chosen, small/mid/big	[Setting method] Enable or disable [Default value] Mid
Area Temperature Type	There are three types of area temperature.	[Setting method] Select a value from the drop-down list box. [Default value] Highest Temperature
Measure Mode	There are two types of measure modes.	[Setting method] Select a value from the drop-down list box. [Default value] General
Display Alarm Area	N/A	[Setting method] Enable or disable [Default value] Disable
Area Alarm Interval (1-1800s)	N/A	[Setting method] Enter a value manually ranges from 1 to 1800. [Default value] 10
Area Alarm delay (0-10S)	N/A	[Setting method] Enter a value manually ranges from 1 to 10. [Default value] 10

Parameter	Description	Setting
Temperature range	It depends on the device. Different devices have different modes, there are two ranges, such as -20 °C -150°C, -40 °C-150°C. The thermal imaging box network camera is -40 °C-150°C.	[Setting method] Select a value from the drop-down list box.
Prevent Overheating	Open, if temperature of the testing area is too high, you can enable it to prevent over heat function. The control cover will be lay down to keep the detector safe. There are two types, manual and auto.	[Setting method] Select a value from the drop-down list box.
Duration(5-60 S)	Prevent over heat' mode is auto, the control cover will block for duration time automatically if over heat.	[Setting method] Enter a value manually ranges from 5 to 60.

Figure 5-2 Advanced Interface

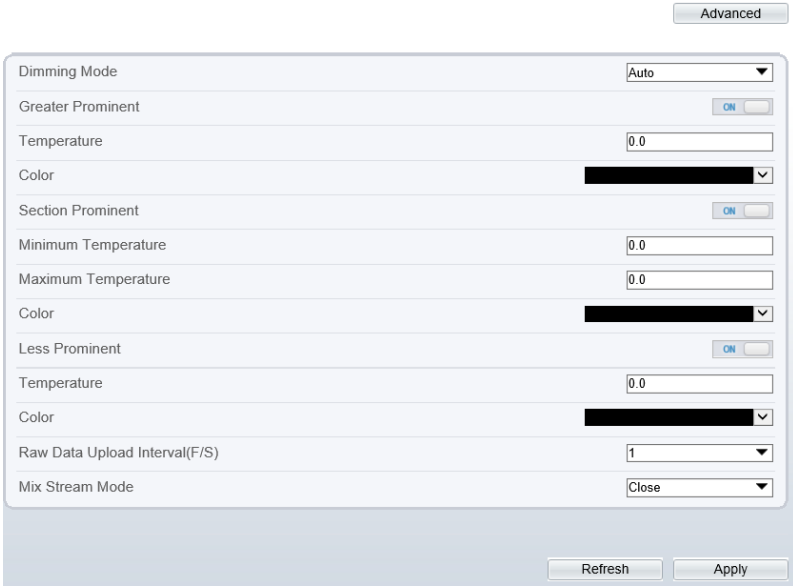

Table 5-2 Advance Parameters

Parameter	Description	Setting
Dimming Mode	There are auto and manual modes. Auto: It will show on temperature item depend on the full screen temperature. Manual: it will show on the manual value.	[Setting method] Select a value from the drop-down list box. [Default value] Auto
Greater Prominent	Enable that, the image will show the setting color if the temperature is higher than set value.	[Setting method] Enter a value manually. Choose one color to show.
Section Prominent	Enable that, the image will show the setting color if the temperature is between minimum and maximum temperature.	[Setting method] Enter a value manually. Choose one color to show.

Parameter	Description	Setting
Less Prominent	Enable that, the image will show the setting color if the temperature is lower than set value.	[Setting method] Enter a value manually. Choose one color to show.
Raw Data Upload Interval(F/S)	Interval of uploading the raw data.	[Setting method] Select a value from the drop-down list box. [Default value] 1
Mix Stream Mode	This function is used for mixing thermal and visible imaging, if you want to adjust the location, please set at thermal channel “ Configuration > Image Settings > Set Pseudocolor” tab interface. There are close, mode 1 mode 2, and mode 3. The different models maybe have different displays; Please refer to the actual product.	[Default value] Close

----End

5.2 Ambient Temperature

Figure 5-3 Ambient Temperature

Ambient Temperature

Ambient Temperature	<input type="text" value="25.00"/>	°C
Cavity Temperature	<input type="text" value="20.62"/>	°C

Table 5-3 Parameter of Ambient Temperature

Parameter	Description	Setting
Ambient Temperature	Environment temperature of camera.	[Setting method] Enter the temperature of ambient environment. [Default value] 25
Cavity Temperature	Set the ambient temperature, click “Apply”, click “Refresh”, the camera will get the value automatically.	---

----End

5.3 Temperature Area

Operation Procedure

Choose **Configuration > Thermal > Temperature Area**.

The **Temperature Area** page is displayed, as shown in Figure 5-4.

Figure 5-4 Temperature Area and Alarm Configuration

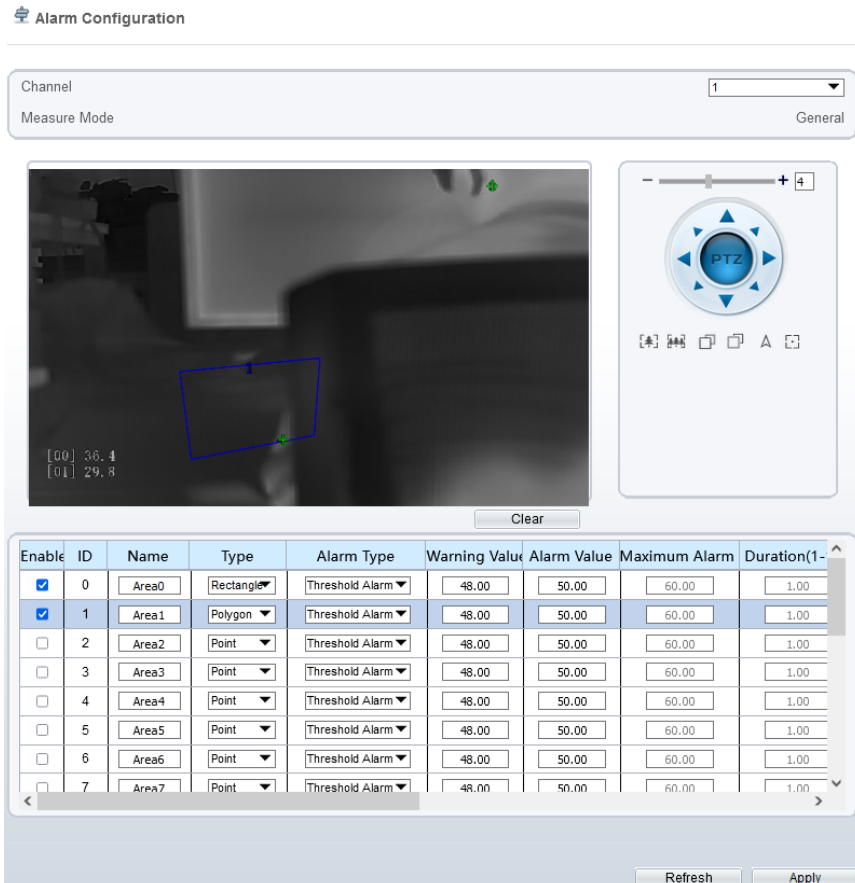

Set the parameters according to Table 5-4.

Table 5-4 Temperature Area and Alarm Configuration

Parameter	Description	Setting
Channel	Channel 1 is thermal channel.	[Setting method] Select a value from the drop-down list box. [Default value] 1

Parameter	Description	Setting
Measure Mode	Set at temperature parameter interface.	N/A
Enable	Tick the ID to enable the area measuring.	[Setting method] Tick
Name	Area name of temperature area.	[Setting method] Enter a value manually.
Type	Type of temperature area. ID 0 is default rectangle area, which is full screen.	[Setting method] Select a value from the drop-down list box. [Default value] Rectangle/Point
Alarm Type	Threshold alarm, temperature difference alarm, section alarm, temperature rise alarm are available for the alarm type. Section Alarm: if the temperature value is among the set temperature range, it will generate the alarm. Temperature rise alarm means it the rising temperature value is more than the set value, it will generate the alarm.	[Setting method] Select a value from the drop-down list box. [Default value] Threshold alarm
Warning Value	Camera will trigger warning alarm when the object temperature reaches the warning value.	[Setting method] Enter a value manually. [Default value] 48
Alarm Value	Camera will alarm when the object temperature reaches the alarm value.	[Setting method] Enter a value manually. [Default value] 50
Maximum Alarm Value	At section alarm type, the device would not alarm when the temperature is higher than maximum alarm value.	[Setting method] Enter a value manually. [Default value] 60.00

Parameter	Description	Setting
Duration (1-10S)	Choose temperature rise alarm, set the duration. the temperature value rises within duration setting, the alarm is triggered successfully.	[Setting method] Enter a value manually. [Default value] 1.00
Emission Rate	The emission rate is the capability of an object to emit or absorb energy. The emission rate should be set only when the target is special material.	[Setting method] Enter a value manually. [Default value] 0.95
Distance(M)	The distance between camera and target.	[Setting method] Enter a value manually. [Default value] 15  NOTE Enter actual distance when the distance between camera and target is less than 15m. Enter 15 when the distance between camera and target is great than or equal to 15m.
Reflect Enable	When there are some high temperature objects on scene, and the temperature reflect to the other object, you can enable this function to calibrate the temperature.	[Setting method] Tick to enable
Reflect Temperature	The temperature of high temperature object.	[Setting method] Enter a value manually. [Default value] 50.00
Ignore Object	Enable to shield the temperature of area capturing AI object.	[Setting method] Select a value from the drop-down list box.
Alarm	Enable or disable the alarm output and linkage of area.	[Setting method] Tick to enable alarm.
Masking	Enable, the device will shield this area's temperature.	[Setting method] Tick to shield.

Parameter	Description	Setting
Group ID	<p>The ID can be chosen into one of six groups, or no group. The group will be alarm following as the next rules:</p> <p>A=The highest temperature of groups (the highest temperature of N regions is the largest)</p> <p>B=Average temperature of groups (average temperature of N regions)</p> <p>WA=Warning value</p> <p>AA=Alarm value</p> <p>a. If $A-B \geq WA$, a temperature difference warning signal is generated ---> (the one with the largest difference between the N areas and the average temperature is the alarm area flashing)</p> <p>b. If $A-B \geq AA$, a temperature difference alarm signal is generated ---> (the one with the largest difference between the N areas and the average temperature is the alarm area flashing)</p> <p>c. If the warning and alarm conditions are met at the same time, the alarm signal will be generated first.</p>	<p>[Setting method]</p> <p>Select a value from the drop-down list box.</p>

Set temperature area.

1. Tick an area ID.
2. Press and hold the left mouse button, and drag in the video area to draw a temperature area, as shown in Figure 5-5. Right-click to finish the area selected.

Figure 5-5 Temperature Area Setting Interface

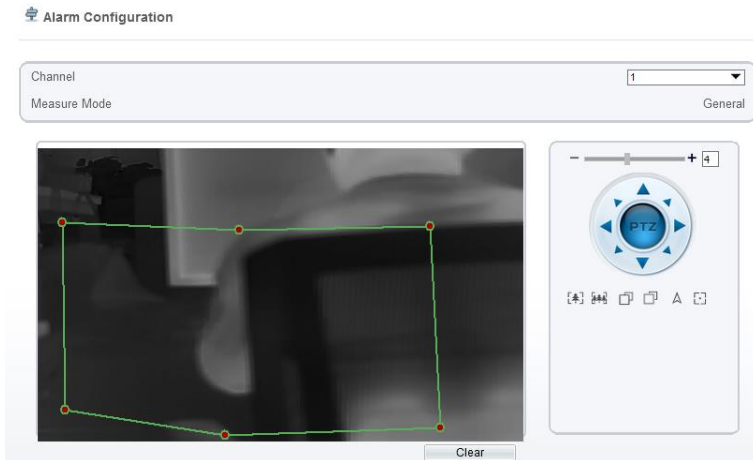

3. Click **Apply**, the message “Apply success” is displayed, the temperature area is set successfully.

 **NOTE**

ID 0 is the full screen; The area cannot be changed.



: the lowest temperature of the full screen.



:the highest temperature of the full screen.



: the lowest temperature of the area.



: the highest temperature of the area.

Delete a temperature area:

1. Select an area ID.
2. Click **Clear**.
3. Remove the tick of area ID.
4. Click **Apply**, the message “Apply success” is displayed, the temperature area is deleted successfully.

Click **Apply**.

The message "Apply success" is displayed, the system saves the settings.

----End

5.4 Privacy Zone Masking

Privacy zone masking means that the camera will do not detect the temperature of that area. The shield areas can be set up to eight areas.

Operation Procedure

Choose **Configuration > Thermal > Privacy Zone Masking**.

Figure 5-6 Privacy Zone Masking

Privacy Zone Masking



Enable the shield area.

Enable Show Privacy Zone Masking, then the setting shield will show on live video.

Click-left mouse button to set area; Click-right mouse button to end the setting.

Click **Clear** to clear the shield area.

----End

5.5 Schedule Linkage

Operation Procedure

Choose **Configuration > Thermal > Schedule Linkage**.

The **Schedule Linkage** page is displayed, as shown in Figure 5-7.

Figure 5-7 Schedule Linkage

 **Schedule Linkage**

Threshold Alarm Threshold Warning Temperature Different Temperature Different Temperature Section /
Temperature Rise Ala Temperature Rise Wa

Output Channel 1

Alarm Record OFF

SMTP OFF

FTP Upload OFF

Audible Alarm OFF

Flashlight Alarm OFF

Armed UnArmed

	0	1	2	3	4	5	6	7	8	9	10	11	12	13	14	15	16	17	18	19	20	21	22	23	24
Sun																									
Mon																									
Tues																									
Wed																									
Thur																									
Fri																									
Sat																									

Refresh Apply

Tick the output channel.

Enable wanted linkage: “Alarm Record”, “SMTP”, “FTP upload”, audible alarm,.
Set schedule linkage.

The message "Apply success" is displayed, the system saves the settings.

 **NOTE**

● **Alarm output:** Users should connect the external alarm device (such as siren) to alarm output cables. The parameter can be set at “ Configuration > Alarm > Alarm Output” interface, as shown in Figure 5-8.

Figure 5-8 Alarm Output

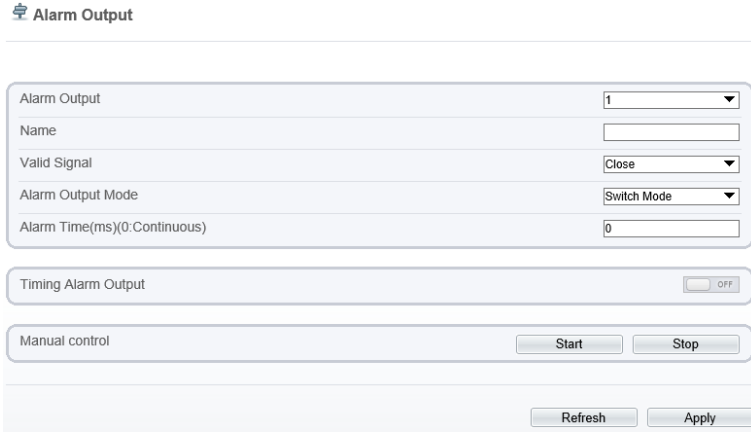

Table 5-5 Alarm Output

Parameter	Description	Setting
Alarm Output	ID of the alarm output channel. NOTE The number of alarm output channels depends on the device model.	[Setting method] Select a value from the drop-down list box. [Default value] 1
Name	Alarm output channel name.	[Value range] 0 to 32 bytes
Valid Signal	The options are as follows: Close: An alarm is generated when an external alarm signal is received. Open: An alarm is generated when no external alarm signal is received.	[Setting method] Select a value from the drop-down list box. [Default value] Close

Parameter	Description	Setting
Alarm Output Mode	<p>When the device receives I/O alarm signals, the device sends the alarm information to an external alarm device in the mode specified by this parameter. The options include the switch mode and pulse mode.</p> <p>NOTE</p> <ul style="list-style-type: none">• If the switch mode is used, the alarm frequency of the device must be the same as that of the external alarm device.• If the pulse mode is used, the alarm frequency of the external alarm device can be configured.	<p>[Setting method] Select a value from the drop-down list box. [Default value] Switch Mode</p>
Alarm Time (ms) (0: Continuous)	Alarm output duration. The value 0 indicates that the alarm remains valid.	<p>[Setting method] Enter a value manually. [Default value] 0 [Value range] 0 to 86400 seconds</p>
Timing Alarm Output	Enable timing alarm output, set the schedule to time alarm.	<p>[Setting method] Enable [Default value] OFF</p>
Manual Control	Control the alarm output.	N/A

- **Alarm Record:** Users insert the SD card in camera. The recording time is set at “**Configuration > Device Record > Record Policy**” interface.
- **SMTP:** At “**Configuration > Network > SMTP**” interface, users should set the parameters of SMTP in advance, as shown in Figure 5-9.

Figure 5-9 SMTP

The screenshot shows the SMTP configuration page. At the top left, there is a signal icon and the text 'SMTP'. The main area contains several input fields and a dropdown menu. The fields are: SMTP Server Address, SMTP Server Port (with '25' entered), User Name, Password, Send anonymously (checkbox), Sender E-mail Address, Recipient E-mail Address1, Recipient E-mail Address2, Recipient E-mail Address3, Recipient E-mail Address4, Recipient E-mail Address5, Transport Mode (dropdown menu with 'No Encrypt' selected), and Send Interval(0-60S) (with '0' entered). At the bottom right, there is an 'Email Test' button. At the very bottom, there are 'Refresh' and 'Apply' buttons.

Table 5-6 SMTP Parameters

Parameter	Description	Setting
SMTP Server Address	IP address of the SMTP server.	[Setting method] Enter a value manually.
SMTP Server Port	Port number of the SMTP server.	[Setting method] Enter a value manually. [Default value] 25
User Name	User name of the mailbox for sending emails.	[Setting method] Enter a value manually.
Password	Password of the mailbox for sending emails.	[Setting method] Enter a value manually.

Parameter	Description	Setting
Sender E-mail Address	Mailbox for sending emails.	[Setting method] Enter a value manually.
Recipient_E-mail_Address 1	(Mandatory) Email address of recipient 1.	[Setting method] Enter a value manually.
Recipient_E-mail_Address 2	(Optional) Email address of recipient 2.	
Recipient_E-mail_Address 3	(Optional) Email address of recipient 3.	
Recipient_E-mail_Address 4	(Optional) Email address of recipient 4.	
Recipient_E-mail_Address 5	(Optional) Email address of recipient 5.	
Attachment Image Quality	A higher-quality image means more storage space. Set this parameter based on the site requirement.	N/A
Transport Mode	Email encryption mode. Set this parameter based on the encryption modes supported by the SMTP server.	[Setting method] Select a value from the dropdown list box. [Default value] No Encrypted

- **FTP Upload:** At “ **Configuration > Network > FTP Upload**” interface, users should set the parameters of FTP upload in advance, as shown in Figure 5-10.

Figure 5-10 FTP Upload

Table 5-7 FTP Upload Parameters





























Parameter	Description	Setting
FTP Upload	Indicates whether to enable the FTP service.	[Setting method] Click the button on. [Default value] OFF
FTP Address	IP address of FTP server.	[Setting method] Enter a value annually.
FTP Port	Port of FTP server.	[Setting method] N/A [Default value] 21
Account	FTP server account.	[Setting method] Enter a value annually.
Password	FTP server Password.	[Setting method] Enter a value annually.
FTP Path	FTP Path to save the JPG image.	[Setting method] Enter a value annually.

Parameter	Description	Setting
Media type	The media type of sending to FTP, snapshot or video clip.	[Setting method] Select a value from the drop-down list box. [Default value] Snapshot

- **Audio Detect Alarm:** At “ **Configuration > Alarm > Audible Alarm Output**” interface, users should set the parameters of audible Alarm output in advance, as shown in Figure 5-11.

Figure 5-11 Audible Alarm Output

 Audible Alarm Output

ID	FileName	Cycle Number	Listen Test	Operate
0	high_temperature_alarm.wav	1		
1	normal_temperature.wav	1		
2	low_temperature_alarm.wav	1		
3	hello_welcome.wav	1		
4	verification_success.wav	1		
5	verification_failed.wav	1		
6	temperature_rise_warning.wav	1		
7	temperature_rise_alarm.wav	1		
8	temperature_range_alarm.wav	1		
9	temperature_diff_alarm.wav	1		
10	temperature_diff_warning.wav	1		
11	high_temperature_warning.wav	1		
12	fire_detected_please_process_immediately.wav	1		
13	smoking_is_prohibited_in_this_area.wav	1		

Armed UnArmed

	0	1	2	3	4	5	6	7	8	9	10	11	12	13	14	15	16	17	18	19	20	21	22	23	24
Sun																									
Mon																									
Tues																									
Wed																									
Thur																									
Fri																									
Sat																									

User can set the audio file manually. Click  to upload the audio file(The type should be WAV, size must be less than 250 Kb, the bit rate should be 128 kbps.), as shown in Figure 5-12.

Figure 5-12 Upload Audio File



----End

5.6 Defect Pixel Correction

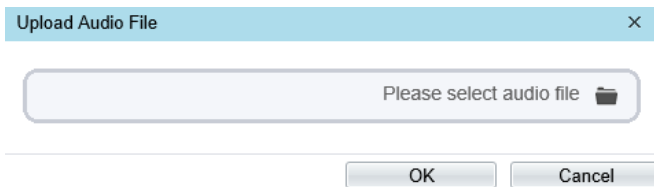
Operation Procedure

Choose **Configuration > Thermal > Defect Pixel Correction**.

The **Defect Pixel Correction** page is displayed, as shown in Figure 5-13.

If the image has a white dot as shown in figure, user can test the function to recover the defect pixel. Users should connect the technical support at this condition to make sure to apply.

Figure 5-13 Defect pixel correction

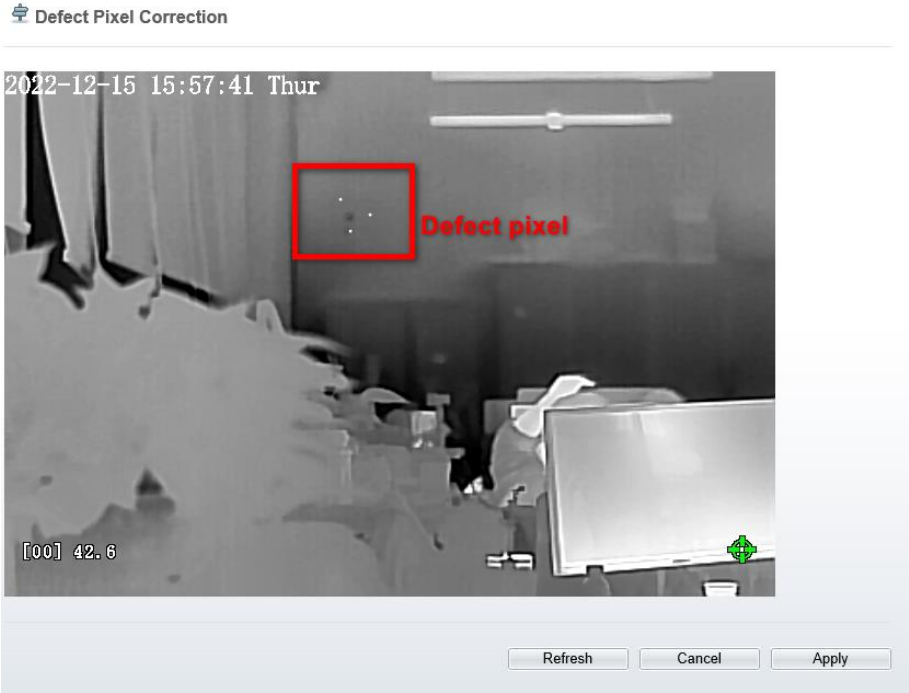

Click the white point at image, click **Refresh** to recover the defect pixel, as shown in Figure 5-14.

Figure 5-14 Recover Defect Pixel



Click **Apply**. The message "Apply success" is displayed, the system saves the settings.

----End

6 Thermal Channel Image Settings

6.1 Access the Image Settings Interface

Operation procedure:

Step 1. When you login web page. Choose **Configuration > Image Settings**. Then the Image Settings display, as show in Figure 6-1

Figure 6-1 Image Settings interface

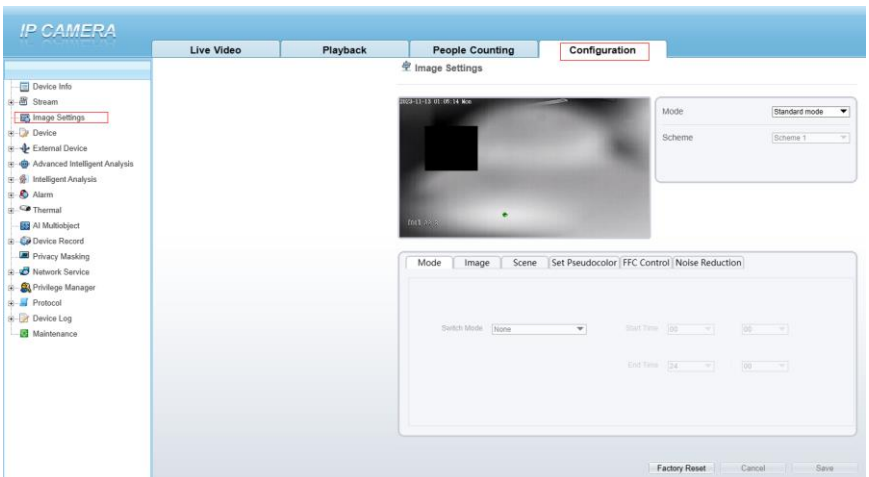

Step 2. Choose the mode is Debug Mode to open image settings dialog box. Then you can adjust image parameter follow your requirement, as show in Figure 6-2

Figure 6-2 Debug Image Settings interface

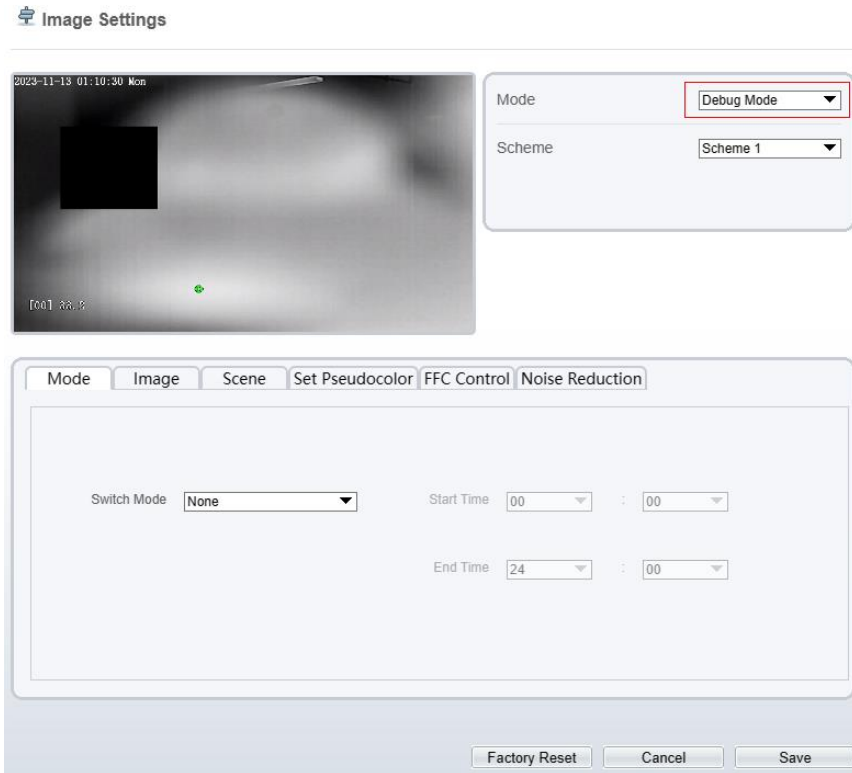

----End

6.2 Image Settings Parameter description

Mode

Operation procedure:

- Step 1. Click **Mode** tag on Image Settings interface, the Mode page is displayed, as shown in Figure 6-3.

Figure 6-3 Mode Interface

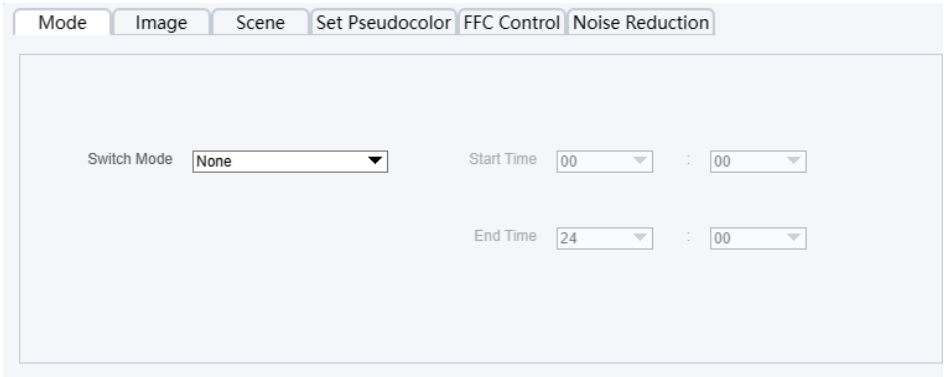

- Step 2. Set the Mode parameters.
- Step 3. Click save to save the setting.

----End

6.3 Image

Figure 6-4 shows the **Image** setting interface.

Figure 6-4 Image Interface

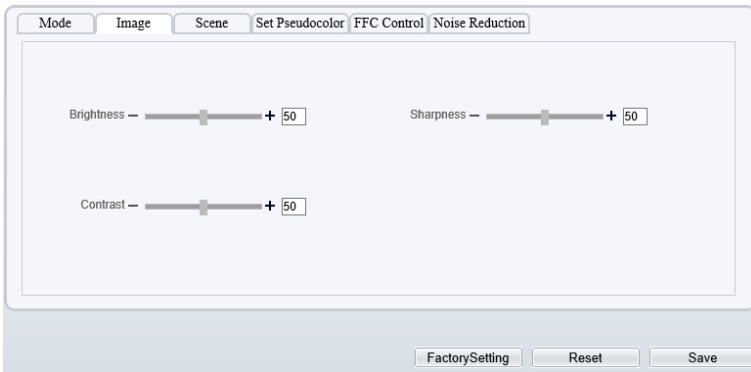

describes the image setting parameters.

Table 6-1 Image setting parameter description

Parameter	Description	Setting
Brightness	It indicates the total brightness of an image. As the value increases, the image becomes brighter.	[Setting method] Drag the

Parameter	Description	Setting
		slider. [Default value] 50
Contrast	It indicates the contrast between the bright part and the dark part of an image. As the value increases, the contrast increases.	[Setting method] Drag the slider. [Default value] 50
Sharpness	It indicates the sharpness of the image plane and the sharpness of the image edge. The shaper the image, the better detail contrast.	[Setting method] Drag the slider. [Default value] 50

----End

6.4 Scene

Figure 6-5 shows the **Scene** setting interface.

Figure 6-5 Scene Interface

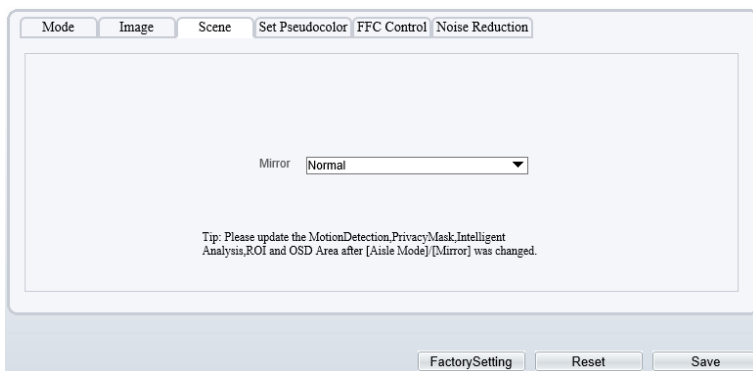

Provide the selection of image pixel locations.

Normal: the image is not flipped.

Horizontal: the image is flipped left and right.

Vertical: the image is flipped up and down.

Horizontal + Vertical: the image upside-down and reversal.

6.5 Set Pseudocolor

Figure 6-6 shows the **Set Pseudocolor** setting interface.

Figure 6-6 Set Pseudocolor Setting Interface

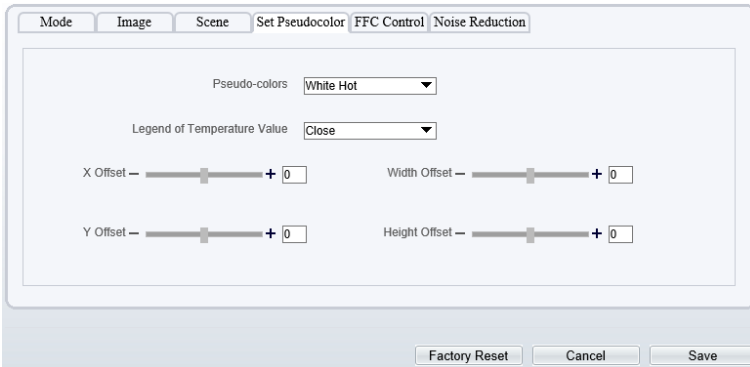

Polarity/LUT: the temperatures of the temperature fields detected by the thermal imaging camera are separately mapped to values ranging from 0 to 255 by the algorithm. In the black/white display mode, this range is converted to the grayscale tones. For example, 0 indicates completely black, and 255 indicates completely white. The temperature field of the scene is converted to images by using the grayscale ranging from 0 to 255. Different polarity modes can be converted to different display images. The most common setting is white hot (a hotter object is displayed brighter than a colder object) or black hot (a hotter object is displayed darker than a colder object). The difference between two modes lies in that the temperatures corresponding to the darker one and the lighter one are reversed. Other modes include rainbow, ironbow, HSV, autumn, bone and so on.

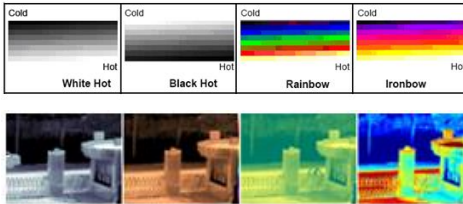

Temperature strip switch is on, the live video will show it, otherwise is no strip.

6.6 FFC Control

Figure 6-7 FFC Control Interface

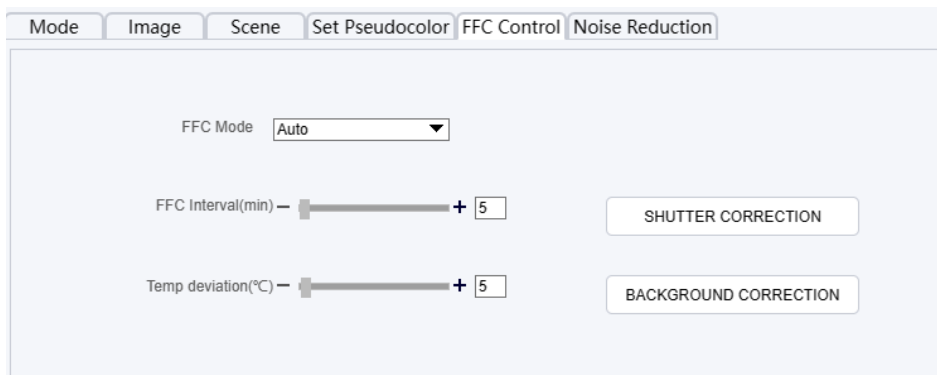

Table 6-2 FFC control parameter description

Parameter	Description	Setting
FFC Mode	<p>The internal of the thermal imaging camera may comprise the mechanical action correction mechanism that can periodically improve the image quality. This component is called flat field correction (FFC). When controlling the FFC, the FFC shields the sensor array, so that each portion of the sensor can collect uniform temperature fields (flat field). By means of FFC, the camera can update the correction coefficients to output more uniform images. Throughout the FFC process, the video image is frozen for two seconds and a static-frame image is displayed. After the FFC is complete, the image is automatically recovered. Repeated FFC operations can prevent the grainy and image degradation problems. The FFC is especially important when the temperature of the camera changes. For example, after the camera is powered on or the ambient temperature is changed, you should immediately perform the FFC.</p> <p>Auto: In the Automatic FFC mode, the camera performs FFC whenever its temperature changes by a specified amount or at the end of a specified period of time</p>	<p>[How to set] Select from the drop-down list box. [Default value] Auto</p>

Parameter	Description	Setting
	<p>(whichever comes first). When this mode is selected, the FFC interval (minutes) ranges from 5 to 30 minutes. The temperature change of the camera is based on the temperatures collected by the internal temperature probe. The temperature of the camera sharply changes when the camera is powered on. The FFC is relatively frequent, which is normal.</p> <p>Manual: In the manual FFC mode, the camera does not automatically perform the FFC based on the temperature change or the specified period. You can press the Do FFC button to select the manual FFC mode. When you feel that the image is obviously degraded but the automatic FFC is not performed, you can use the manual FFC function to check whether the image quality can be improved.</p>	
FFC Interval (min)	In the automatic FFC mode, the FFC interval ranges from 5 to 255 minutes.	[How to set] Drag the slider. [Default value] 5
Temper Interval	In the automatic FFC mode, the FFC interval ranges from 5 to 25.5 centigrade.	[How to set] Drag the slider. [Default value] 5
SHUTTER CORRECTION	Click the icon to adjust exposure immediately.	N/A
BACKGROUND CORRECTION	Click the icon and cover the camera with something to adjust image. Remove the thing to finish adjustment.	N/A

---End

6.7 Noise Reduction

Figure 6-8 shows the **Noise reduction** interface.

Figure 6-8 Noise Reduction Interface

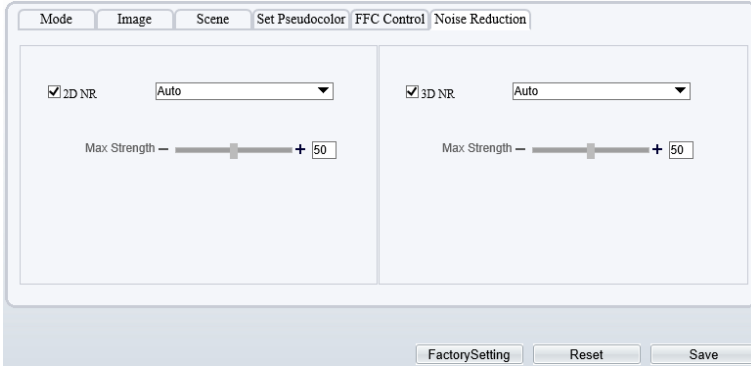

Table 6-3 lists the Noise reduction parameters.

Table 6-3 Parameters of Noise Reduction Interface

Parameter	Description	Setting
2DNR	Decrease the image noise.	[How to set] Select from the drop-down list box. [Default value] Close
3DNR	Decrease the image noise.	[How to set] Select from the drop-down list box. [Default value] Close

----End

7 Intelligent Analysis

There are many kinds of intelligent analysis, such as **Intrusion, Single Line Crossing, Double Line Crossing, Multi-Loitering, Retrograde, People Counting, Enter Area, Leave Area**. The parameters of these analysis alarm are roughly similar, so we will describe someone in detail as a reference.

Intrusion: The Intrusion function refers to that an alarm is generated when target objects (such as person, car, and both person and car) enter the deployment area.

Single Line Crossing: A Single Line Crossing is a line that is set at a concerned position within the monitored field of view and specifies the forbidden travel direction; An alarm is generated when the targets of specified types (such as person or car) cross this line.

Double Line Crossing: Double Line Crossing refers to two lines that are set at a concerned special position within the field of view and specify the forbidden travel direction. When the targets of specified types (such as person or car) move along the set travel direction and cross these lines in a certain order (line 1 followed by line 2) in pass max time, an alarm is generated.

Multi-Loitering: Multi-Loitering allows setting the shortest loitering time for multiple targets of specified type (such as person or car) within the deployment area in the field of view. When the loitering time of the multiple targets within this area meets the set shortest loitering time, an alarm is generated.

Retrograde: Retrograde allows setting the travel direction criteria for a target within an area on the video screen. When a target of specified type (such as people or car) within this area moves in the set travel direction, an alarm is generated.

People Counting: Users can draw line to count the number of people in the special area.

Enter Area: The enter area refers to that an alarm is generated when a target enters the deployment area at the valid time.

Leave Area: The leave area refers to that an alarm is generated when a target leaves the deployment area at the valid time.

7.1 Intrusion

The Intrusion function refers to that an alarm is generated when the targets of specified types (such as person, car, and both person and car) enter the deployment area.

Procedure

Step 1. Select **Intelligent Analysis** > **Intrusion** to access the **Intrusion** interface, as shown in Figure 7-1.

Figure 7-1 Intrusion Setting Interface

 Intrusion

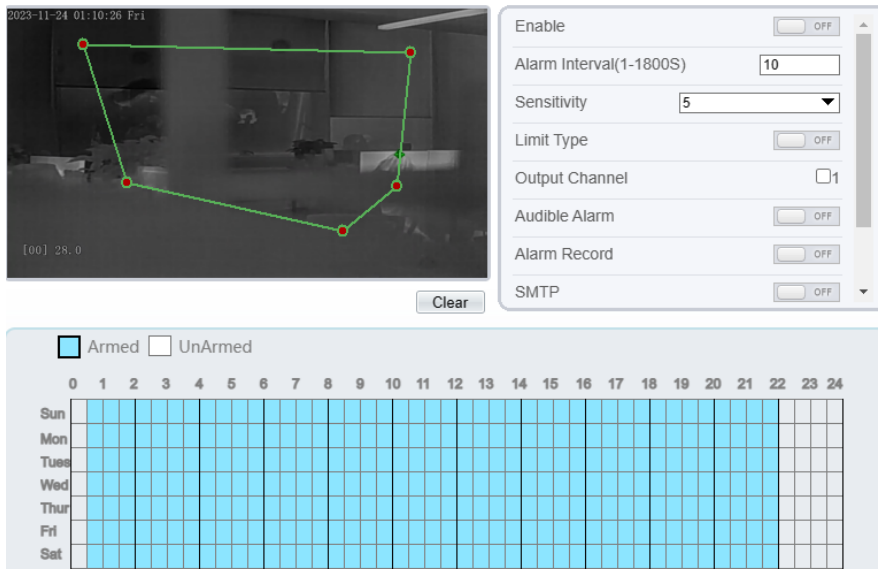

Step 2. Set all parameters for Intrusion. Table 7-1 describes the specific parameters.

Table 7-1 Parameter of Intrusion

Parameter	Description	Setting
Enable	Enable the button to enable the alarm.	[How to set] Click Enable to enable. [Default value] OFF
Alarm Interval (1-1800s)	N/A	[Setting method] Enter a value manually ranges from 1 to 1800. [Default value] 10

Parameter	Description	Setting
Sensitivity	The sensitivity of detecting the target, when the value is high, the target can be detected easily, but the accuracy will be lower.	[How to set] Choose from the drop-down list [Default value] 5
Limit Target Type	Effective alarms are set based on target type, with options of Person or Car, person, car. When the device is used indoors, because of small space and large targets, alarms are triggered by person sometimes even if car is selected, leading to false alarms. It is recommended to set the target type as person for indoor use.	[How to set] Click to enable Limit Target Type. [Default value] OFF
Output Channel	If you check to set the Output Channel and the device is connected to an external alarm indicator, the alarm indicator signals when an alarm is triggered.	[How to set] Click to select an ID.
Audible Alarm	Enable, when the alarm happens, it will be play audio to alarm. Choose the audible alarm file (set at the “ Configuration > Alarm > Audible Alarm Output ”).	[How to set] Click to enable Audio Detection Alarm [Default value] OFF
Alarm Record	Enable the button to enable the alarm record.	[How to set] Click to enable Alarm Record. [Default value] OFF
SMTP	Enable the button to enable SMTP sever. The parameters of SMTP can be set at Configuration > Network Service > SMTP interface.	[How to set] Click to enable SMTP. [Default value] OFF

Parameter	Description	Setting
FTP Upload	Enable the button to enable File Transfer Protocol. The parameters of FTP can be set at Configuration > Network Service > FTP interface.	[How to set] Click to enable FTP Upload. [Default value] OFF
Video Stream Draw Line	Enable, the deployment frame will show on the live video.	[How to set] Click to enable Video Stream Draw Line. [Default value] OFF

Step 3. Set a deployment area

Move the cursor to the drawing interface and click to generate a point, move the cursor to draw a line, and then click to generate another point. This is how a line is generated. In this way, continue to draw lines to form any shape, and right-click to finish line drawing.

NOTE

- A drawn line cannot cross another one, or the line drawing fails.
- Any shape with 8 sides at most can be drawn.
- The quantity of deployment areas is not limited yet and will be described in future when a limit is applied.

Step 4. Set deployment time

Method 1: Click left mouse button to select any time point within 0:00-24:00 from Monday to Sunday as shown in Figure 7-2.

Method 2: Hold down the left mouse button, drag and release mouse to select the deployment time within 0:00-24:00 from Monday to Sunday.

NOTE

When you select time by dragging the cursor, the cursor cannot be moved out of the time area. Otherwise, no time can be selected.

Method 3: Click  in the deployment time page to select the whole day or whole week.

Deleting deployment time: Click  again or inverse selection to delete the selected deployment time.

Figure 7-2 Deployment Time Setting Interface



---End

7.2 Single Line Crossing

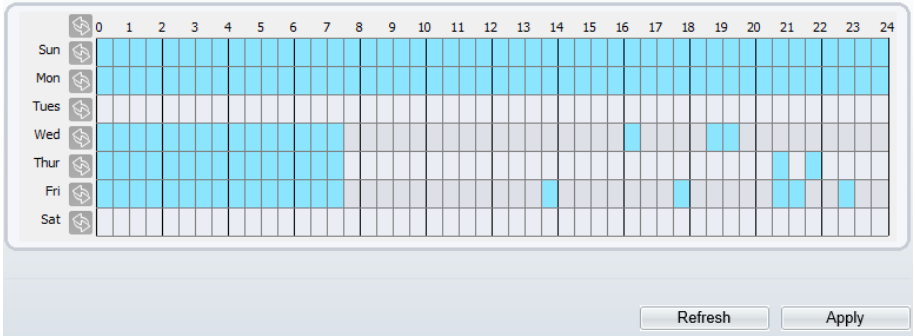
A single line crossing is a line that is set at a concerned position within the monitored field of view and specifies the forbidden travel direction, an alarm is generated when the targets of specified types (such as person or car) cross this line.

Procedure

- Step 1. Select **Intelligent Analysis > Single Line Crossing** to access the **Single Line Crossing** setting interface, as shown in Figure 7-3.

Figure 7-3 Single Line Crossing Setting Interface

Single Line Crossing

Step 2. Set all parameters for the single line crossing. Table 7-2 describes the specific parameters.

Table 7-2 Parameters of Single Line Crossing

Parameter	Description	Setting
Enable	Enable the button to enable the alarm.	[How to set] Click Enable to enable . [Default value] OFF
Alarm Interval (1-1800s)	N/A	[Setting method] Enter a value manually ranges from 1 to 1800. [Default value] 10

Parameter	Description	Setting
Limit Target Type	Effective alarms are set based on target type, with options of Person or Car, person, car. When the device is used indoors, because of small space and large targets, alarms are triggered by person sometimes even if car is selected, leading to false alarms. It is recommended to set the target type as person for indoor use.	[How to set] Click to enable Limit Target Type. [Default value] OFF
Output Channel	If you check to set the Output Channel and the device is connected to an external alarm indicator, the alarm indicator signals when an alarm is triggered.	[How to set] Click to select an ID.
Audible Alarm	Enable, when the alarm happens, it will be play audio to alarm. Choose the audible alarm file (set at the “ Configuration > Alarm > Audible Alarm Output ”).	[How to set] Click to enable Audio Detection Alarm [Default value] OFF
Alarm Record	Enable the button to enable the alarm record.	[How to set] Click to enable Alarm Record. [Default value] OFF
SMTP	Enable the button to enable SMTP sever. The parameters of SMTP can be set at Configuration > Network Service > SMTP interface.	[How to set] Click to enable SMTP. [Default value] OFF
FTP Upload	Enable the button to enable File Transfer Protocol. The parameters of FTP can be set at Configuration > Network Service > FTP interface.	[How to set] Click to enable FTP. [Default value] OFF
Video Stream Draw Line	Enable, the deployment frame will show on the live video.	[How to set] Click to enable Video Stream Draw Line. [Default value] OFF

Step 3. Set a deployment area

Drawing a line: move the cursor to the drawing interface, hold down the left mouse button, and move the cursor to draw a line. When you release the left mouse button, a Single Line Crossing is generated.

Setting a single line crossing: click a line (and the trip line turns red) to select the Single Line Crossing and set its direction as **positive**, **reverse** or **bidirectional**, or **delete the selected** line. You can also press and hold left mouse button at the endpoint of a Single Line Crossing and move the mouse to modify the position and length of this single virtual fence. You can right-click to delete the single virtual fence.

NOTE

- A single line crossing is not within any deployment area, therefore, when an alarm is generated, the trace always exists. Only when the target object moves out of the field of view, the trace disappears.
- Try to draw the single line crossing in the middle, because the recognition of a target takes time after target appearance on the screen and an alarm is generated only when the object is recognized to have crossed the single virtual fence.
- The single line crossing which detects person foot as the recognition target cannot be too short, because a short single line crossing tends to miss targets.

Step 4. Set deployment time.

For more details please refer to *7.1 Step 4*.

----End

7.3 Double Line Crossing

Double Line Crossing refer to two lines that are set at a concerned special position within the field of view and specify the forbidden travel direction. When the targets of specified types (such as person or car) move along the set travel direction and cross these lines in a certain order (line 1 followed by line 2) in pass max time, an alarm is generated.

Procedure

- Step 1. Select **Intelligent Analysis > Double Line Crossing** to access the **Double Line Crossing** setting interface, as shown in Figure 7-4.

Figure 7-4 Double Line Crossing Setting Interface

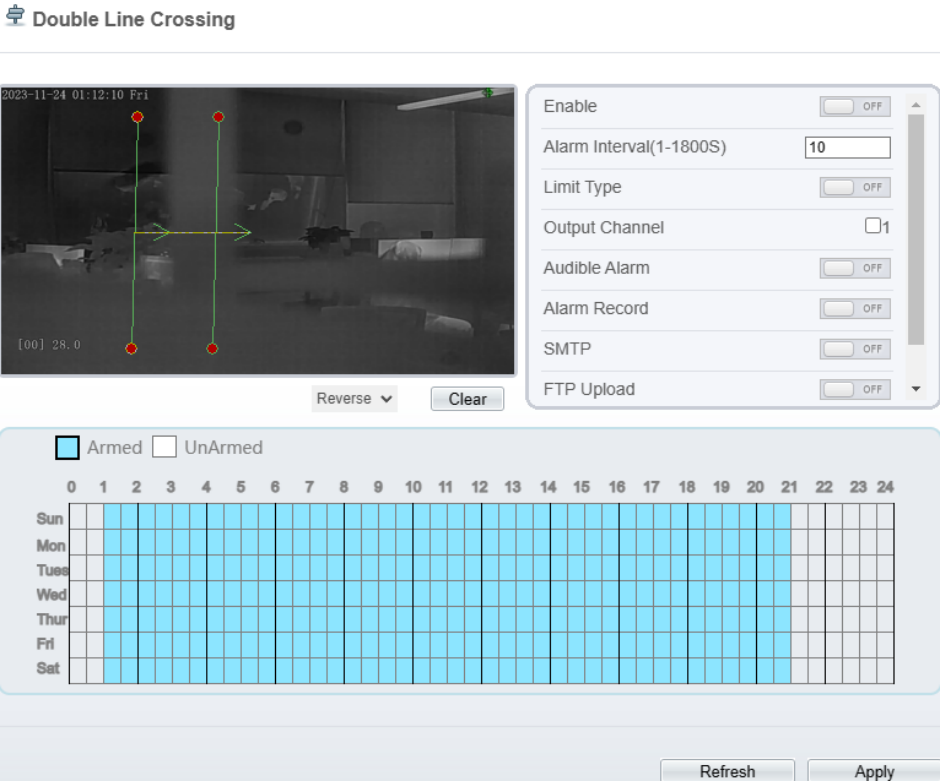

Step 2. Set all parameters for the double line crossing. Table 7-3 describes the specific parameters.

Table 7-3 Parameters of Double Line Crossing

Parameter	Description	Setting
Enable	Enable the button to enable the alarm.	[How to set] Click to enable. [Default value] OFF

Parameter	Description	Setting
Alarm Interval (1-1800s)	N/A	[Setting method] Enter a value manually ranges from 1 to 1800. [Default value] 10
Limit Target Type	Effective alarms are set based on target type, with options of Person or Car, person, car. When the device is used indoors, because of small space and large targets, alarms are triggered by person sometimes even if car is selected, leading to false alarms. It is recommended to set the target type as person for indoor use.	[How to set] Click to enable Limit Target Type. [Default value] OFF
Output Channel	If you check to set the Output Channel and the device is connected to an external alarm indicator, the alarm indicator signals when an alarm is triggered.	[How to set] Click to select an ID.
Audible Alarm	Enable, when the alarm happens, it will be play audio to alarm. Choose the audible alarm file (set at the “ Configuration > Alarm > Audible Alarm Output ”).	[How to set] Click to enable Audio Detection Alarm [Default value] OFF
Alarm Record	Enable the button to enable the alarm record.	[How to set] Click to enable Alarm Record. [Default value] OFF
SMTP	Enable the button to enable SMTP sever. The parameters of SMTP can be set at Configuration > Network Service > SMTP interface.	[How to set] Click to enable SMTP. [Default value] OFF

Parameter	Description	Setting
FTP Upload	Enable the button to enable File Transfer Protocol. The parameters of FTP can be set at Configuration > Network Service > FTP interface.	[How to set] Click to enable FTP. [Default value] OFF
Video Stream Draw Line	Enable, the deployment frame will show on the live video.	[How to set] Click to enable Video Stream Draw Line. [Default value] OFF

Step 3. Set a deployment area

Drawing a line: Move the cursor to the drawing interface, hold down the left mouse button, and move the cursor to draw two lines. When you release the left mouse button, two numbered virtual fences are generated. Choose either of the double line crossing to set the direction to Positive or Reverse.

Setting double line crossing: Click one of the double line Crossing (and the virtual fence turns red) to select this virtual fence and set the direction to **Positive** or **Reverse**, or delete the selected line. You can also press and hold left mouse button at the endpoint of a virtual fence and move the mouse to modify the position and length of this virtual fence. You can right-click to delete the double line crossing.

 **NOTE**

- The double line crossing are in sequential order. An alarm is generated only when a target crosses virtual fence 1 and then virtual fence 2 within the set maximum passing time.
- The double line crossing are not within any deployment area, therefore, when an alarm is generated, the trace always exists. Only when the target object moves out of the field of view, the trace disappears.
- Try to draw double line crossing in the middle, because the recognition of a target takes time after target appearance on the screen and an alarm is generated only when the object is recognized to have crossed the double virtual fences.
- The double line crossing which detect person foot as the recognition target cannot be too short, because short Double Line Crossing tend to miss targets.

Step 4. Set deployment time.

For more details please refer to *7.1 Step 4*.

----**End**

7.4 Multi-Loitering

Multi-loitering allows setting the shortest loitering time for multiple targets of specified type (such as person or car) within the deployment area in the field of view. When the loitering time of the multiple targets within this area meets the set shortest loitering time, an alarm is generated.

Procedure

Step 1. Select **Intelligent Analysis > Multi-Loitering** to access the **Multi-Loitering** setting interface, as shown in Figure 7-5.

Figure 7-5 Multi-Loitering Setting Interface

Multi-Loitering

The screenshot displays the Multi-Loitering configuration interface. At the top left, a video feed shows a room with a green polygon overlaid on it, indicating the loitering area. The video timestamp is 2023-11-24 01:12:41 Fri. Below the video is a 'Clear' button. To the right of the video is a settings panel with the following options:

- Enable: OFF
- Alarm Interval(1-1800S):
- Limit Numbers: OFF
- The Shortest Time(5-60s):
- Output Channel: 1
- Audible Alarm: OFF
- Alarm Record: OFF
- SMTP: OFF

Below the settings panel is a legend for the calendar grid: Armed UnArmed. The calendar grid shows days of the week (Sun to Sat) and hours (0 to 24). The grid is currently empty, indicating no loitering schedule is set. At the bottom right of the interface are 'Refresh' and 'Apply' buttons.

Step 2. Set all parameters for multiple loitering. Table 7-4 describes the specific parameters.

Table 7-4 Parameters of Multi-Loitering

Parameter	Description	Setting
Enable	Enable the button to enable the alarm.	[How to set] Click Enable to enable. [Default value] OFF
Alarm Interval (1-1800s)	N/A	[Setting method] Enter a value manually ranges from 1 to 1800. [Default value] 10
Limit Target Size	The target size for triggering an effective alarm is set based on the actual target size. The minimum size is 1000 square centimeters and the maximum size is 100000 square centimeters. When setting the target size, you need to well set “Real size in scene” in advanced parameters, otherwise no alarms may be generated.	[How to set] Click to enable Limit Target Size. [Default configuration] OFF
Limit Numbers	When Limit Numbers is set to OFF, an alarm is generated no matter how many people loiter. When Limit Numbers is set to ON, if the minimum number is set to 2 and the maximum number is set to 3, an alarm is generated for 2-3 people loitering. Other settings are the same as loitering.	[How to set] Click to enable Limit Numbers.
The Shortest Time (Sec)	The time that the target person wanders in the area must not be less than the minimum time. Settable range: 5-60s	[How to set] Input a value in the area box. [Default value] 10s
Output Channel	If you check to set the Output Channel and the device is connected to an external alarm indicator, the alarm indicator signals when an alarm is triggered.	[How to set] Click to select an ID.

Parameter	Description	Setting
Audible Alarm	Enable, when the alarm happens, it will be play audio to alarm. Choose the audible alarm file (set at the “ Configuration > Alarm > Audible Alarm Output ”).	[How to set] Click to enable Audio Detection Alarm [Default value] OFF
Alarm Record	Enable the button to enable the alarm record.	[How to set] Click to enable Alarm Record. [Default value] OFF
SMTP	Enable the button to enable SMTP sever. The parameters of SMTP can be set at Configuration > Network Service > SMTP interface.	[How to set] Click to enable SMTP. [Default value] OFF
FTP Upload	Enable the button to enable File Transfer Protocol. The parameters of FTP can be set at Configuration > Network Service > FTP interface.	[How to set] Click to enable FTP Upload. [Default value] OFF
Video Stream Draw Line	Enable, the deployment frame will show on the live video.	[How to set] Click to enable Video Stream Draw Line. [Default value] OFF

Step 3. Set a deployment area.

Move the cursor to the drawing interface and click to generate a point, move the cursor to draw a line, and then click to generate another point. This is how a line is generated. In this way, continue to draw lines to form any shape, and right-click to finish line drawing.

NOTE

- A drawn line cannot cross another one, or the line drawing fails.
- Any shape with 8 sides at most can be drawn .
- The quantity of deployment areas is not limited yet and will be described in future when a limit is applied.

Step 4. Set deployment time

Details please refer to *7.1 Step 4*

----End

7.5 Retrograde

Retrograde allows setting the travel direction criteria for a target within an area on the video screen. When a target of specified type (such as people or car) within this area moves in the set travel direction, an alarm is generated.

Procedure

Step 1. Select **Intelligent Analysis** > **Retrograde** to access the **Retrograde** setting interface, as shown in Figure 7-6.

Figure 7-6 Retrograde Setting Interface

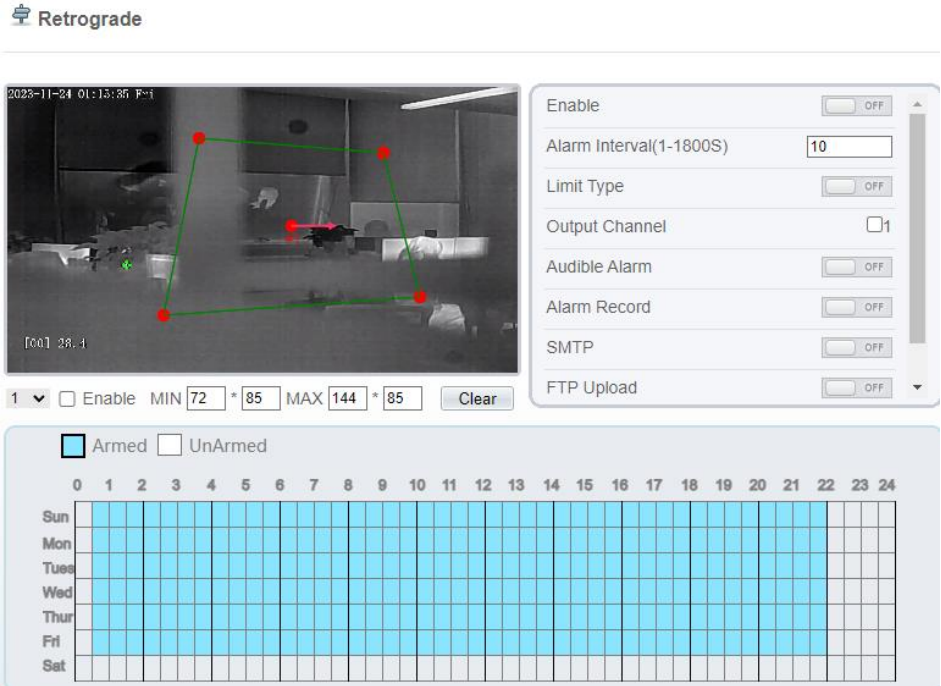

Step 2. Set all parameters for Retrograde. Table 7-5 describes the specific parameters.

Table 7-5 Parameter of Retrograde

Parameter	Description	Setting
Enable	Enable the button to enable the alarm.	[How to set] Click Enable to enable. [Default value] OFF

Parameter	Description	Setting
Alarm Interval (1-1800s)	N/A	[Setting method] Enter a value manually ranges from 1 to 1800. [Default value] 10
Limit Target Type	Effective alarms are set based on target type, with options of Person or Car, person, car. When the device is used indoors, because of small space and large targets, alarms are triggered by person sometimes even if car is selected, leading to false alarms. It is recommended to set the target type to person for indoor use.	[How to set] Click to enable Limit Target Type. [Default value] OFF
Output Channel	If you check to set the Output Channel and the device is connected to an external alarm indicator, the alarm indicator signals when an alarm is triggered.	[How to set] Click to select an ID.
Audible Alarm	Enable, when the alarm happens, it will be play audio to alarm. Choose the audible alarm file (set at the “ Configuration > Alarm > Audible Alarm Output ”).	[How to set] Click to enable Audio Detection Alarm [Default value] OFF
Alarm Record	Enable the button to enable the alarm record.	[How to set] Click to enable Alarm Record. [Default value] OFF
SMTP	Enable the button to enable SMTP sever. The parameters of SMTP can be set at Configuration > Network Service > SMTP interface.	[How to set] Click to enable SMTP. [Default value] OFF
FTP Upload	Enable the button to enable File Transfer Protocol. The parameters of FTP can be set at Configuration > Network Service > FTP interface.	[How to set] Click to enable FTP Upload. [Default value] OFF

Parameter	Description	Setting
Video Stream Draw Line	Enable, the deployment frame will show on the live video.	[How to set] Click to enable Video Stream Draw Line. [Default value] OFF

Step 3. Set a deployment area

Move the cursor to the drawing interface and click to generate a point, move the cursor to draw a line, and then click to generate another point. This is how a line is generated. In this way, continue to draw lines to form any shape, and right-click to finish line drawing, move the arrow in the field can set the direction of Retrograde.



NOTE

- A drawn line cannot cross another one, or the line drawing fails.
- Any shape with 8 sides at most can be drawn .
- The quantity of deployment areas is not limited yet and will be described in future when a limit is applied.

Step 4. Set deployment time

Details please refer to *7.1 Step 4*.

----End

7.6 People Counting

Draw a line in the designated area to count, you can count the number of people passing through the area, set the corresponding alarm linkage.

Procedure

- Step 1. Select **Intelligent Analysis > People Counting** to access the **People Counting** setting interface, as shown in Figure 7-7.

Figure 7-7 People Counting

 People Counting

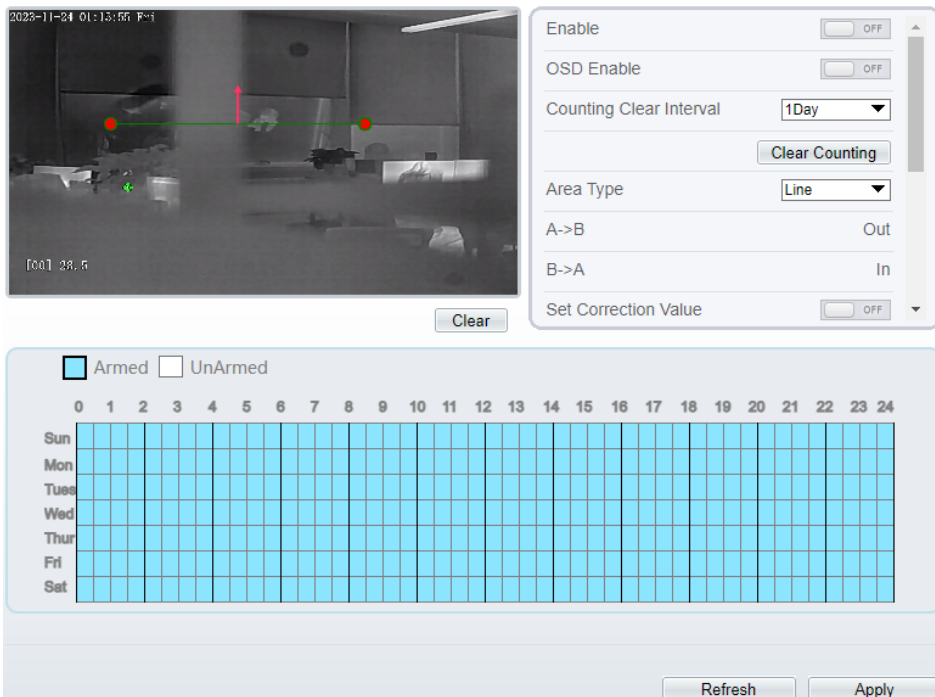

2023-11-24 01:13:56 F-1

1001 23.5

Clear

Enable OFF

OSD Enable OFF

Counting Clear Interval 1Day

Clear Counting

Area Type Line

A->B Out

B->A In

Set Correction Value OFF

Armed UnArmed

	0	1	2	3	4	5	6	7	8	9	10	11	12	13	14	15	16	17	18	19	20	21	22	23	24
Sun																									
Mon																									
Tue																									
Wed																									
Thur																									
Fri																									
Sat																									

Refresh Apply

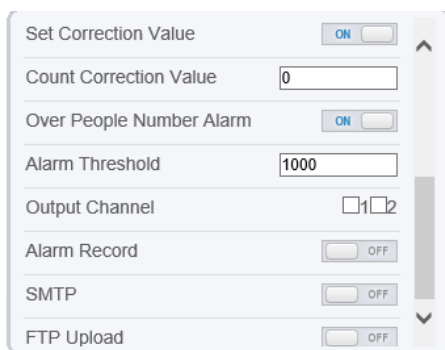

Set Correction Value ON

Count Correction Value 0

Over People Number Alarm ON

Alarm Threshold 1000

Output Channel 1 2

Alarm Record OFF

SMTP OFF

FTP Upload OFF

Step 2. Set all parameters for **People Counting**. Table 7-6 describes the specific parameters.

Table 7-6 Parameters of People Counting

Parameter	Description	Setting
Enable	Enable the button to enable the alarm.	[How to set] Click Enable to enable. [Default value] OFF
OSD Enable	Enable the OSD, the count data will show on live video screen.	[How to set] Click Enable to enable. [Default value] OFF
Counting Clear Interval	The camera will clear counting data at the setting interval. Click the “Clear Counting”, clearing the data immediately.	[How to set] Choose from drop-down list. [Default value] 12 hours
Area Type	Draw a line on live video screen. The label of A and B indicate out and in.	[How to set] Choose from drop-down list. [Default value] Line
Set Correction Value	Enable, set the count correction value, it can be positive or negative. For example, if there are 30 people enter the area before counting, input 30 to correct. If 30 people go out the area, input -30.	[How to set] Enable /Input a value in the area box. [Default value] 0
Over People Number Alarm	Enable, When the counting number reaches the threshold value, an alarm is triggered.	[How to set] Click Enable to enable. [Default value] OFF
Alarm Threshold	There is an alarm when the number reaches or exceeds this value.	[How to set] Enable /Input a value in the area box. [Default value] 1000

Parameter	Description	Setting
Output Channel	If you check to set the Output Channel and the device is connected to an external alarm indicator, the alarm indicator signals when an alarm is triggered.	[How to set] Click to select an ID.
Audible Alarm	Enable, when the alarm happens, it will be play audio to alarm. Choose the audible alarm file (set at the “ Configuration > Alarm > Audible Alarm Output ”).	[How to set] Click to enable Audio Detection Alarm [Default value] OFF
Alarm Record	Enable the button to enable the alarm record.	[How to set] Click to enable Alarm Record. [Default value] OFF
SMTP	Enable the button to enable SMTP sever. The parameters of SMTP can be set at Configuration > Network Service > SMTP interface.	[How to set] Click to enable SMTP. [Default value] OFF
FTP Upload	Enable the button to enable File Transfer Protocol. The parameters of FTP can be set at Configuration > Network Service > FTP interface.	[How to set] Click to enable FTP Upload. [Default value] OFF

Step 3. Set a deployment area

Move the cursor to the drawing interface and click to generate a point, move the cursor to draw a line, and then click to generate another point. This is how a line is generated. In this way, continue to draw lines to form any shape, and right-click to finish line drawing.

Step 4. Set deployment time

For more details please refer to *7.1 Step 4*.

----End

7.7 Enter Area

Set the area, when the targets enter the area, it will alarm.

Procedure

Step 1. Select **Intelligent Analysis** > **Enter Area** to access the **Enter Area** setting interface, as shown in Figure 7-8.

Figure 7-8 Enter Area

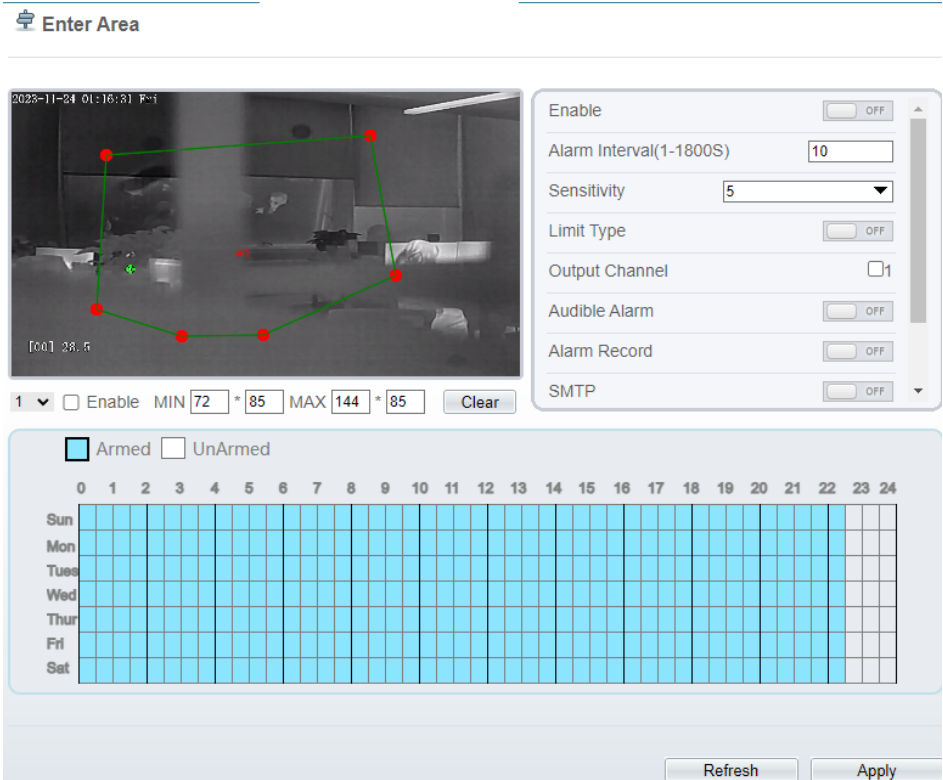

Step 2. Set all parameters for illegal parking. Figure 7-7 describes the specific parameters.

Table 7-7 Description of Parameters for Enter Area

Parameter	Description	Setting
Enable	Enable the button to enable the enter area alarm.	[How to set] Click Enable to enable. [Default value] OFF

Parameter	Description	Setting
Alarm Interval (1-1800s)	N/A	[Setting method] Enter a value manually ranges from 1 to 1800. [Default value] 10
Sensitivity	The sensitivity of detecting the target, when the value is high, the target can be detected easily, but the accuracy will be lower.	[How to set] Choose from the drop-down list [Default value] 5
Limit Target Type	Effective alarms are set based on target type, with options of Person or Car, person, car. When the device is used indoors, because of small space and large targets, alarms are triggered by person sometimes even if car is selected, leading to false alarms. It is recommended to set the target type to person for indoor use.	[How to set] Click to enable Limit Target Type. [Default value] OFF
Output Channel	If you check to set the Output Channel and the device is connected to an external alarm indicator, the alarm indicator signals when an alarm is triggered.	[How to set] Click to select an ID.
Audible Alarm	Enable, when the alarm happens, it will be play audio to alarm. Choose the audible alarm file (set at the “ Configuration > Alarm > Audible Alarm Output ”).	[How to set] Click to enable Audio Detection Alarm [Default value] OFF
Alarm Record	Enable the button to enable the alarm record.	[How to set] Click to enable Alarm Record. [Default value] OFF
SMTP	Enable the button to enable SMTP sever. The parameters of SMTP can be set at Configuration > Network Service > SMTP interface.	[How to set] Click to enable SMTP. [Default value] OFF

Parameter	Description	Setting
FTP Upload	Enable the button to enable File Transfer Protocol. The parameters of FTP can be set at Configuration > Network Service > FTP interface.	[How to set] Click to enable FTP Upload. [Default value] OFF
Video Stream Draw Line	Enable, the deployment frame will show on the live video.	[How to set] Click to enable Video Stream Draw Line. [Default value] OFF

Step 3. Set a deployment area

Move the cursor to the drawing interface and click to generate a point, move the cursor to draw a line, and then click to generate another point. This is how a line is generated. In this way, continue to draw lines to form any shape, and right-click to finish line drawing.

Step 4. Set deployment time

For more details please refer to *7.1 Step 4*.

---End

7.8 Leave Area

When the targets leave the setting area, it will be alarm.

Procedure

Step 1. Select **Intelligent Analysis > Leave Area** to access the **Leave Area** setting interface, as shown in Figure 7-9.

Figure 7-9 Leave Area

 Leave Area

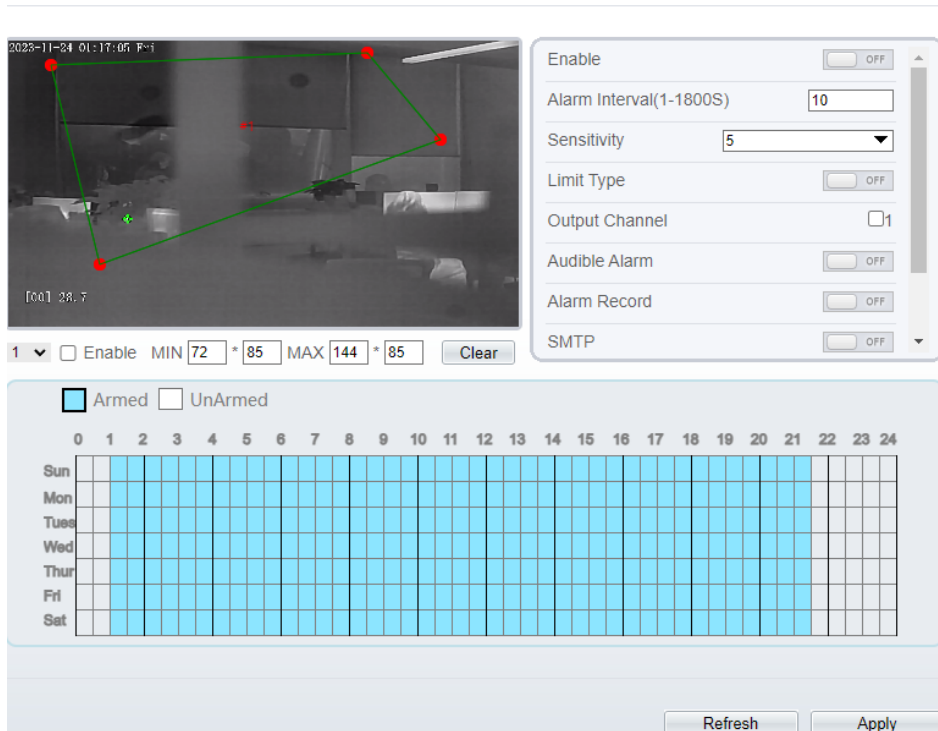

2023-11-24 01:17:05 F-1

[00] 28.7

1 Enable MIN 72 * 85 MAX 144 * 85 Clear

Enable OFF

Alarm Interval(1-1800S) 10

Sensitivity 5

Limit Type OFF

Output Channel 1

Audible Alarm OFF

Alarm Record OFF

SMTP OFF

Armed UnArmed

0 1 2 3 4 5 6 7 8 9 10 11 12 13 14 15 16 17 18 19 20 21 22 23 24

Sun

Mon

Tue

Wed

Thur

Fri

Sat

Refresh Apply

Step 2. Set all parameters for illegal parking. Figure 7-9. describes the specific parameters.

Table 7-8 Parameters of Leave Area

Parameter	Description	Setting
Enable	Enable the button to enable the leave area alarm.	[How to set] Click Enable to enable. [Default value] OFF

Parameter	Description	Setting
Alarm Interval (1-1800s)	N/A	[Setting method] Enter a value manually ranges from 1 to 1800. [Default value] 10
Sensitivity	The sensitivity of detecting the target, when the value is high, the target can be detected easily, but the accuracy will be lower.	[How to set] Choose from the drop-down list [Default value] 5
Limit Target Type	Effective alarms are set based on target type, with options of Person or Car, person, car. When the device is used indoors, because of small space and large targets, alarms are triggered by person sometimes even if car is selected, leading to false alarms. It is recommended to set the target type to person for indoor use.	[How to set] Click to enable Limit Target Type. [Default value] OFF
Output Channel	If you check to set the Output Channel and the device is connected to an external alarm indicator, the alarm indicator signals when an alarm is triggered.	[How to set] Click to select an ID.
Audible Alarm	Enable, when the alarm happens, it will be play audio to alarm. Choose the audible alarm file (set at the “ Configuration > Alarm > Audible Alarm Output ”).	[How to set] Click to enable Audio Detection Alarm [Default value] OFF
Alarm Record	Enable the button to enable the alarm record.	[How to set] Click to enable Alarm Record. [Default value] OFF
SMTP	Enable the button to enable SMTP sever. The parameters of SMTP can be set at Configuration > Network Service > SMTP interface.	[How to set] Click to enable SMTP. [Default value] OFF

Parameter	Description	Setting
FTP Upload	Enable the button to enable File Transfer Protocol. The parameters of FTP can be set at Configuration > Network Service > FTP interface.	[How to set] Click to enable FTP Upload. [Default value] OFF
Video Stream Draw Line	Enable, the deployment frame will show on the live video.	[How to set] Click to enable Video Stream Draw Line. [Default value] OFF

Step 3. Set a deployment area

Move the cursor to the drawing interface and click to generate a point, move the cursor to draw a line, and then click to generate another point. This is how a line is generated. In this way, continue to draw lines to form any shape, and right-click to finish line drawing.

Step 4. Set deployment time.

Details please refer to *7.1 Step 4*.

----**End**

7.9 Smart Motion

Description

The smart motion function refers to that an alarm is generated when target objects (such as person, car, and both person and car) move at the deployment area.

Procedure

Step 1 Select **Intelligent Analysis > Smart Motion**, as shown in Figure 7-10

Figure 7-10 Smart Motion Setting Interface

 Smart Motion

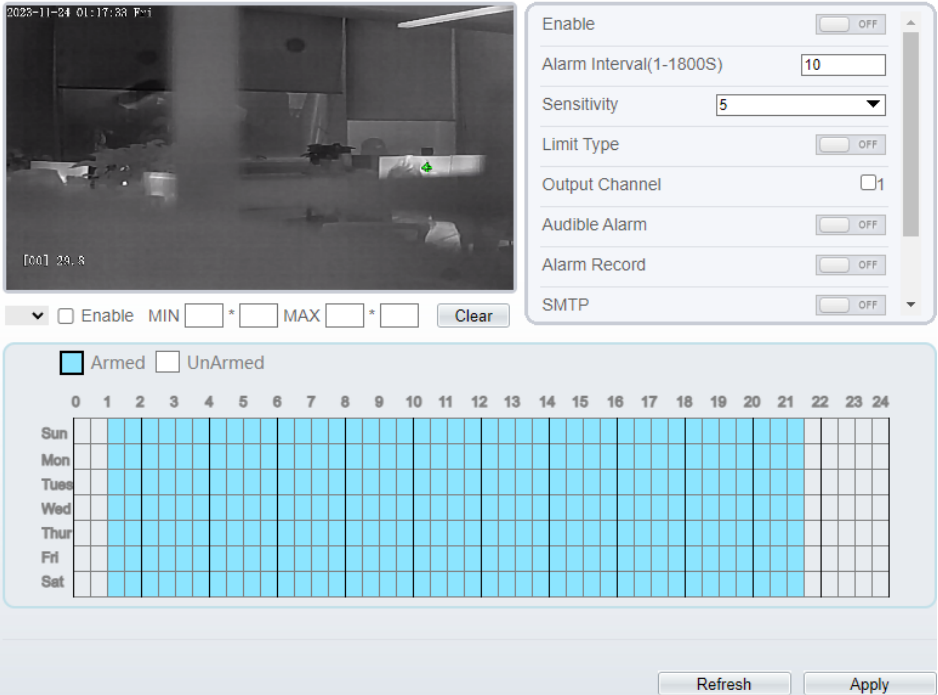

Step 2 Set all parameters of smart motion. Table 7-9 describes the specific parameters.

Table 7-9 Smart Motion Parameter Description

Parameter	Description	Setting
Enable	Enable the button to enable the alarm.	[How to set] Click the button on. [Default value] OFF

Parameter	Description	Setting
Alarm Interval (1-1800s)	N/A	[Setting method] Enter a value manually ranges from 1 to 1800. [Default value] 10
Sensitivity	The sensitivity of detecting the target, when the value is high, the target can be detected easily, but the accuracy will be lower.	[How to set] Choose from the drop-down list [Default value] 5
Limit Type	Enable to choose the limit type (person or car / person / car) from type drop-down list.	[How to set] Click the button on. [Default value] OFF
Output Channel	If you check to set the Output Channel and the device is connected to an external alarm indicator, the alarm indicator signals when an alarm is triggered. Only for Some Models.	[How to set] Click to select an ID.
Audible Alarm	Enable, when the alarm happens, it will be play audio to alarm. Choose the audible alarm file (set at the “ Configuration > Alarm > Audible Alarm Output ”).	[How to set] Click to enable Audio Detection Alarm [Default value] OFF
Audible Alarm	Enable, when the alarm happens, it will be play audio to alarm. Choose the audible alarm file (set at the “ Configuration > Alarm > Audible Alarm Output ”).	[How to set] Click to enable Audio Detection Alarm [Default value] OFF
Alarm Record	Enable the button to enable the alarm record.	[How to set] Click to enable Alarm Record. [Default value] OFF
SMTP	Enable the button to enable SMTP sever.	[How to set] Click to enable SMTP. [Default value] OFF

Parameter	Description	Setting
FTP Upload	Enable the button to enable File Transfer Protocol. More details please refer to chapter Table 9-1.	[How to set] Click to enable FTP Upload. [Default value] OFF

Step 3 Set a deployment area

Move the cursor to the drawing interface and click to generate a point, move the cursor to draw a line, and then click to generate another point. This is how a line is generated. In this way, continue to draw lines to form any shape, and right-click to finish line drawing.

 **NOTE**

- A drawn line cannot cross another one, or the line drawing fails.
- Any shape with 8 sides at most can be drawn.
- The quantity of deployment areas is up to 8.

Step 4 Set deployment time

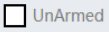
Click the armed icon  to set the arming time. Click the Unarmed icon  to set the unarming time.

Method 1: Click left mouse button to select any time point within 0:00-24:00 from Monday to Sunday.

Method 2: Hold down the left mouse button, drag and release mouse to select the deployment time within 0:00-24:00 from Monday to Sunday.

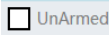
Deleting deployment time: Click  to delete the selected deployment time. The methods are same as set deployment time.

 **NOTE**

When you select time by dragging the cursor, the cursor cannot be moved out of the time area. Otherwise, no time can be selected.

Figure 7-11 Deployment Time Setting Interface

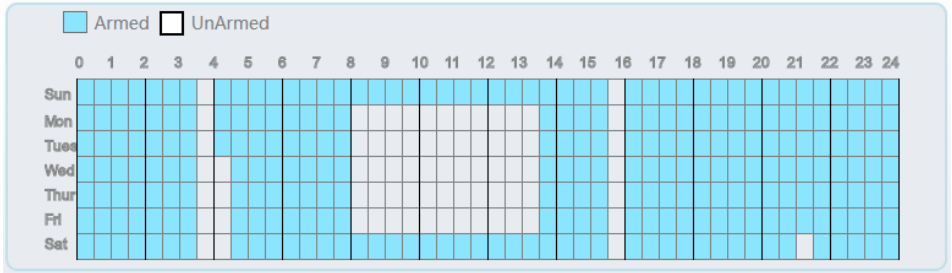

----End

8 Advanced Intelligent Analysis

At the advanced intelligent analysis interface, users can set the parameters of smoker detection, smoke and flame detection, and fire spot detection. Enable the linkage actions, the alarm information can be sent to user by the linkage.

The advanced intelligent analysis can be used for detecting the smoking, if someone smoke in the indoor where smoking is forbidden.

Smoke and Flame Detection can be used for detecting smoke and fire, it can send alarm information to avoid fire getting worse.

Fire Spot Detection can be used for finding the catching fire to quickly operate to extinguish.

8.1 Smoker Detection

Description

The smoker detection function refers to that an alarm is generated when someone is smoking or generating spark at the deployment area.

Procedure

Select **Configuration > Advanced Intelligent Analysis > Smoker Detection** to access the **Smoker Detection** interface, as shown in Figure 8-1.

Figure 8-1 Smoker Detection Interface

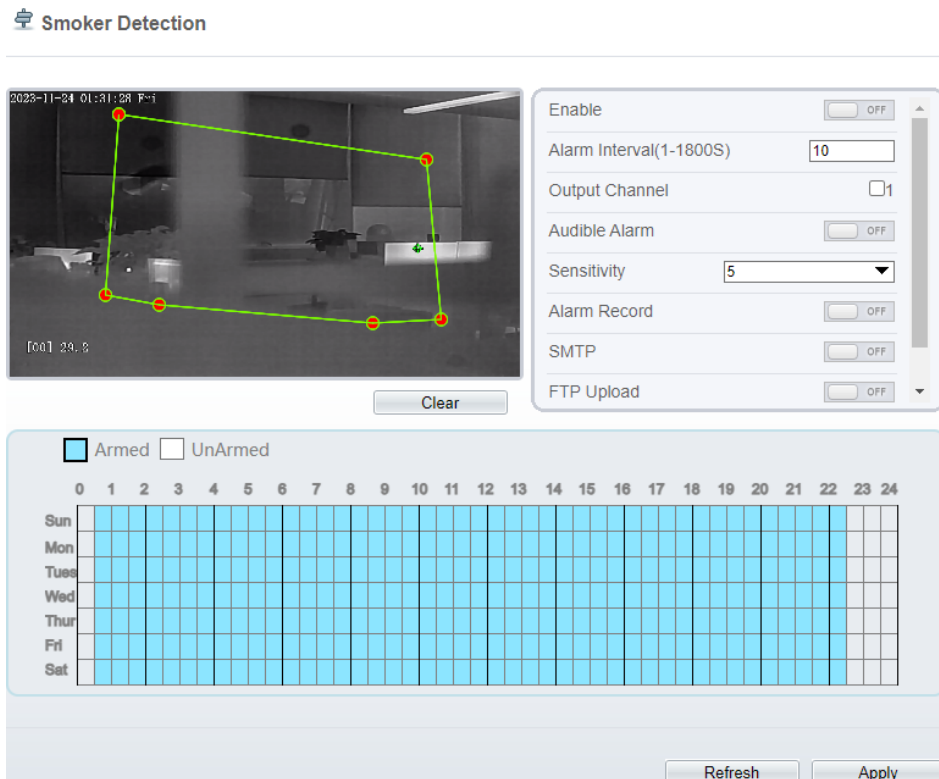

Set all parameters for Smoker Detection. Table 8-1 describes the specific parameters.

Table 8-1 Parameters of Smoker Detection

Parameter	Description	Setting
Enable	At thermal channel, Enable the button to enable the alarm.	[How to set] Click Enable to enable. [Default value] OFF
Alarm Interval (1-1800s)	N/A	[Setting method] Enter a value manually ranges from 1 to 1800. [Default value] 10

Parameter	Description	Setting
Output Channel	If you check to set the Output Channel and the device is connected to an external alarm indicator, the alarm indicator signals when an alarm is triggered.	[How to set] Click to select an ID.
Audible alarm	Enable, when an alarm occurs, it will play audio to alarm. Choose the audible alarm file (set at the “ Configuration > Alarm > Audible Alarm Output ”).	[How to set] Click to enable Audible alarm [Default value] OFF
Sensitivity	The sensitivity of detecting smoker, when the value is high, the alarm can be triggered easily, but the accuracy will be lower.	[How to set] Choose from the drop-down list [Default value] 5
Alarm Record	Enable the button to enable the alarm record.	[How to set] Click to enable Alarm Record. [Default value] OFF
SMTP	Enable the button to enable SMTP serve.	[How to set] Click to enable SMTP. [Default value] OFF
FTP Upload	Enable the button to enable File Transfer Protocol.	[How to set] Click to enable FTP Upload. [Default value] OFF
Video Stream Draw Line	Enable the button to enable Video Stream Draw Line, the setting area frame will show on live video.	[How to set] Click to enable Video Stream Draw Line. [Default value] OFF

Set a deployment area. Move the cursor to the drawing interface and click to generate a point, move the cursor to draw a line, and then click to generate another point. This is how a line is generated. In this way, continue to draw lines to form any shape, and right-click to finish line drawing.

**NOTE**

- A drawn line cannot cross another one, or the line drawing fails.
- Any shape with 32 sides at most can be drawn.
- The quantity of deployment areas is up to 8.

Set deployment time.

Click **Apply** to save the settings.

----**End**

8.2 Fire Spot Detection

Description

The fire spot detection function refers to that an alarm is generated when something is on fire at the deployment area.

Procedure

Select **Configuration > Advanced Intelligent Analysis > Fire Spot Detection** to access the **Fire Spot Detection** interface, as shown in Figure 8-2

Figure 8-2 Fire Spot Detection Interface

 Fire Spot Detection

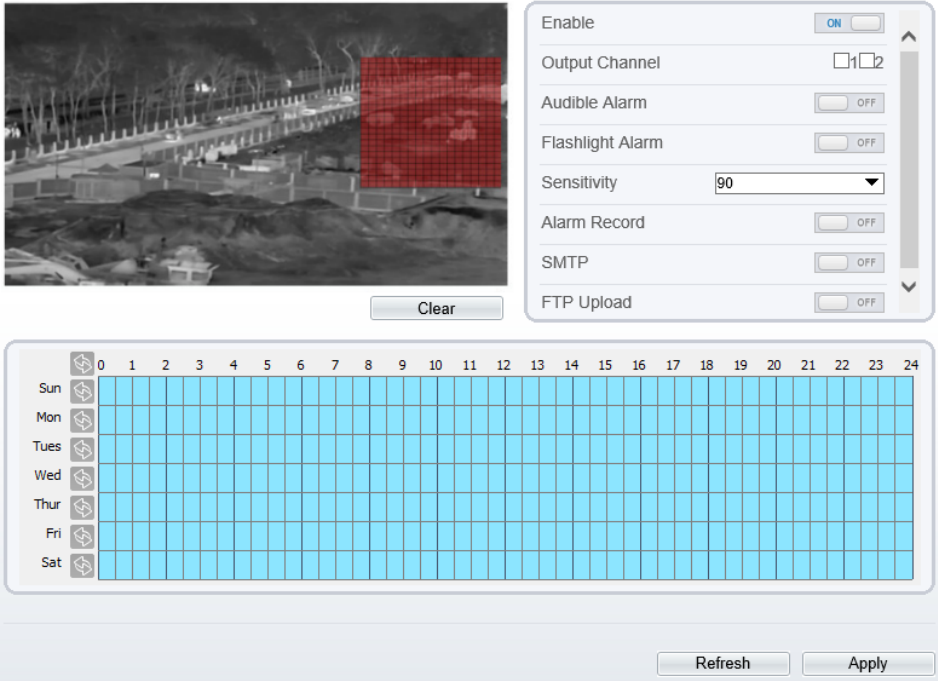

Set all parameters for Fire Spot Detection. Table 8-2 describes the specific parameters.

Table 8-2 Fire Spot Detection Description

Parameter	Description	Setting
Enable	At thermal channel, Enable the button to enable the alarm.	[How to set] Click Enable to enable. [Default value] OFF
Alarm Interval (1-1800s)	N/A	[Setting method] Enter a value manually ranges from 1 to 1800. [Default value] 10

Parameter	Description	Setting
Output Channel	If you check to set the Output Channel and the device is connected to an external alarm indicator, the alarm indicator signals when an alarm is triggered.	[How to set] Click to select an ID.
Audible alarm	Enable, when an alarm occurs, it will play audio to alarm. Choose the audible alarm file (set at the “ Configuration > Alarm > Audible Alarm Output ”).	[How to set] Click to enable Audible alarm [Default value] OFF
Sensitivity	The sensitivity of detecting smoker, when the value is high, the temperature of triggering alarm is lower; When the value is low, the temperature of triggering alarm is higher.	[How to set] Choose from the drop-down list [Default value] 90
Alarm Record	Enable the button to enable the alarm record.	[How to set] Click to enable Alarm Record. [Default value] OFF
SMTP	Enable the button to enable SMTP serve.	[How to set] Click to enable SMTP. [Default value] OFF
FTP Upload	Enable the button to enable File Transfer Protocol.	[How to set] Click to enable FTP Upload. [Default value] OFF

Set a deployment area.

Use mouse to draw rectangular area, you can set several area to deploy, as shown in Figure 8-3.

Figure 8-3 Set Deployment Area

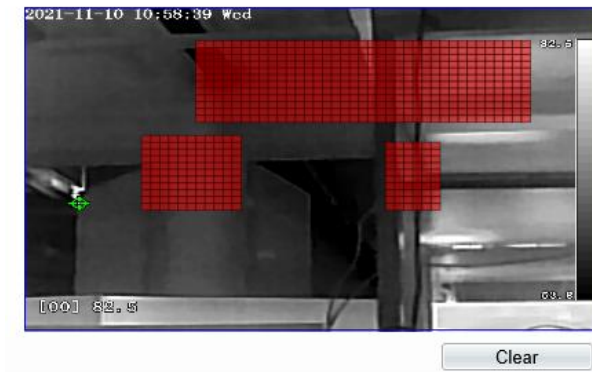

 **NOTE**

- A drawn line cannot cross another one, or the line drawing fails.
- Any shape with 32 sides at most can be drawn.
- The quantity deployment areas is up to 8.

Set deployment time.

Click **Apply** to save the settings.

---End

9 AI Multi-object

At “ Configuration > AI Multiobject ” interface, user can enable full-body detection, vehicle detection to detect the person and vehicle, as shown in Figure 9-1.

Figure 9-1 AI Multiobject

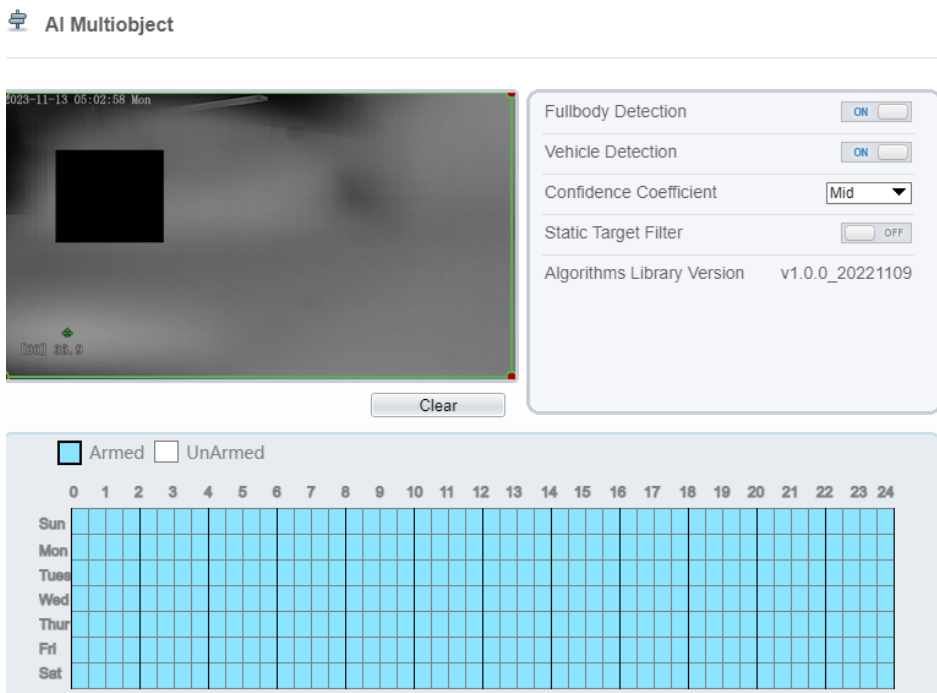

Set the parameters of AI multiobject following as the Table 9-1 .

Table 9-1 AI Multiobject Parameters

Parameter	Description	How to set
-----------	-------------	------------

Full body detection	The camera will snap the whole body when someone appear in live video. The detection frame is blue.	Enable
Vehicle detection	The camera will snap the licence when the vehicle appear in live video. The detection frame is yellow.	Enable
Confidence Coefficient	The range of snap image, there are three type, such as high, mid and low. The higher the confidence, the better the snap quality and the fewer snapshots.	Choose from drop list.
Static Target Filter	If the target is static, the device will filter this target. For example, if a car stop for long time, the device will be filtered.	Enable

Draw the detection area by using the mouse.
Set the schedule, click “Apply” to save the settings.

--End

A Troubleshooting

Common Trouble	Possible Cause	Solution
Unable to access the web	Network is not connected.	<ul style="list-style-type: none"> • Connect the network cable of the camera to the PC to check whether the network cable is in good contact. • Run the ping command to check the network connection and whether the device works normally.
	IP address is occupied.	Directly connect the camera to the PC, and reset the IP address of the camera.
	The IP addresses of the PC and the device are in different networks.	Check the IP address, subnet mask and gateway setting of the camera.
PTZ or high speed dome is out of control.	The protocol, bit-rate, or address setting of the PTZ is incorrect.	Modify the address of the PTZ on the web.
	The signal cable is unconnected or not connected correctly.	Check the signal strength, and reconnect the signal cable.
The measured temperature is not accurate.	The device is just powered on, and the temperature of the cavity is unstable.	The temperature of the cavity is stable within 15 to 30 min after the device is powered on.
	The FFC mode is incorrect.	The FFC mode is auto by default. If the mode is set to manual, it will be no block calibration, which may lead to fuzzy pictures and inaccurate temperature.
	The target configuration is incorrect.	Check whether the emission rate and distance of the target are configured correctly.

Common Trouble	Possible Cause	Solution
An error occurs in accessing the web of the device after the upgrade.	The data in the cache of browser is not updated in time.	<p>Delete the cache of the Internet Explorer. The steps are as follows (taking IE9 as an example):</p> <ol style="list-style-type: none"> 1. Open the Internet Explorer. 2. Select Tools > Internet Options. 3. On the General tab, select Delete under Browsing history. The Delete Browsing History dialog box appears. 4. Select all check boxes. 5. Click Delete. <p>Relogin the web page of the camera.</p>
Upgrade failed.	No network cable is connected.	Ensure the upgrade network is connected.
	The network setting is incorrect.	Check whether the network setting is correct.
	The upgrade package is incorrect.	Perform the correct upgrade package again.
No self-test no image output	There is a broken line in the circuit	Find breakpoints, rewiring.
	Low supply voltage	Replace the power adapter to increase the output voltage.
Self-test exception	Low supply voltage	Replace the power adapter to increase the output voltage.
Equipment control is normal, image instability (Analog video)	Poor video circuit contact	Troubleshooting, rewiring
	Access device exception	Replacement access device
Equipment control is	Network line bad contact	Dismantling bad point, re-wiring.

Common Trouble	Possible Cause	Solution
normal, image instability (Web video)	Access to computer performance is insufficient, take up CPU usage	Lower stream and resolution
	Lack of network bandwidth	Replacement of industrial Gigabit switches
	Access decoder performance decoder	Replacement of high-performance
Self-test normal, cannot control	Wrong wiring	Rewiring
	Set the baud rate, protocol, address and device mismatch	Screen configuration according to device parameters
Repeated restart	Insufficient supply voltage or voltage instability	To ensure that the input device voltage stability
Cannot control the lens to perform zoom and Focus action	Wiring error	Re-connect the lens control line
	Circuit board lens control problems	Replacement circuit board (please contact after-sales rework processing, do not replace parts or repair)
Cannot recall the set lens preset point	DIP switch relative to the set lens preset dialing is not set to ON	DIP switch control lens preset dialing dial into ON
The image is lost when the control device rotates	Rotation process at the same location lost image	Conductive slip ring there is a bad contact, replace the parts (please contact after-sales rework, do not replace parts or repair)

B Common Emission Rate

Emission Rate

The emission rate is the capability of an object to emit or absorb energy. An ideal transmitter provides an emission rate of emitting 100% of intake energy. An object with an emission rate of 0.8 can absorb 80% of intake energy, and reflect the remaining 20%. The emission rate is the ratio of the energy emitted by an object at a specific temperature to that emitted by an ideal radiator at the same temperature. The range of emission rate value is 0.0 to 1.0 generally.

Materials	Temperature (°C/°F)	Emissivity
Gold (High-purity)	227/440	0.02
Aluminum foil	27/81	0.04
Aluminum sheet	27/81	0.18
Aluminum used for families (flat)	23/73	0.01
Aluminum plate (98.3% purity)	227/440	0.04
	577/1070	0.06
Aluminum plate (rough)	26/78	0.06
Aluminum (oxidized @ 599°C)	19 /390	0.11
	599/1110	0.19
Polished aluminum	38/100	0.22
Tin (light tinned Iron sheet)	25/77	0.04

Nickel wire	187/368	0.1
Lead (99.9% purity, No oxidized)	127/260	0.06
Copper	199/390	0.18
Cobalt	599/1110	0.19
Steel	199/390	0.52
	599/1110	0.57
Tinned iron sheet (Light)	28/82	0.23
Brass(High-polish)	247/476	0.03
Brass (Tough rolled, polished metal wire)	21/70	0.04
Tinned Iron (Light)	-	0.13
Iron plate (Rust eaten)	20/68	0.69
Rolled steel sheet	21/71	0.66
Ferric oxide	100/212	0.74
Wrought-iron	21/70	0.94
Fused iron	1299-1399/2370-2550	0.29
Copper (Polished)	21-117/70-242	0.02
Copper(Polished, not reflected)	22/72	0.07
Copper (Heavy oxide Board)	25/77	0.78
Enamel (Fuse on iron)	19/66	0.9
Formica Plate	27/81	0.94

Frozen soil	-	0.93
Brick (Red, rough)	21/70	0.93
Brick (Unglazed, rough)	1000/1832	0.8
Carbon (T - carbon 0.9% ash)	127/260	0.81
Concrete	-	0.94
Glass (Glossy)	22/72	0.94
Granite (Surfaced)	21/70	0.85
Ice	0/32	0.97
Marble (I Polished, grey)	22/72	0.93
Asbestos board	23/74	0.96
Asbestos paper	38/100	0.93
	371/700	0.95
Asphalt (Paving the road)	4/39	0.97
Paper (Black tar)	-	0.93
Paper (White)	-	0.95
Plastic (White)	-	0.91

101-200-0156-01